



**SPECIALIZED  
IN LED ALYZED  
OUTDOOR LIGHT**

VER.6.24

**iLite UK** THE LIGHTING PEOPLE

Website: [WWW.iliteuk.com](http://WWW.iliteuk.com)

Email: [sales@iliteuk.com](mailto:sales@iliteuk.com)

Address: 1 Hatton Street, London, United Kingdom, NW8 8PL



iLite UK THE LIGHTING PEOPLE

---

14 years of focus on the development, design, and manufacturing of outdoor waterproof landscape lighting products

VER. 24

## Factory Strength

Our factory has strong capabilities and resources to support our custom services in the outdoor lighting industry. Here are the key highlights of our factory's strengths.

Own facilities and manufacturing technology:

Our factory is equipped with advanced equipment and manufacturing technology, including high-precision machining equipment, automated production lines, and precise testing. These facilities and technologies ensure the quality and performance of our products.



Research and Development Capabilities:

We prioritize innovation and R&D, continuously introducing new products and solutions that meet market demands. Our R&D team collaborates closely with industry experts and partners to maintain a leading position in technology and design.



Quality Control:

We strictly adhere to a quality management system, implementing rigorous quality control at every stage, from raw material procurement to production. We are committed to delivering products that meet international standards and customer requirements.

Professional Team:

We have a professional team comprising experienced engineers, designers, and technical personnel. They possess industry knowledge and expertise, enabling them to provide high-level design, manufacturing, and technical support.

**14**  
YEARS

Structural engineer with 14 years of experience in outdoor lighting field

**10**  
YEARS

Electronic engineer with 10 years of work experience

**15**  
YEARS

Quality control engineer with 15 years of experience in outdoor lighting



Resource Supply Chain:

We have established long-term stable partnerships with excellent suppliers, ensuring access to high-quality raw materials and components. This allows us to guarantee product quality and supply stability.



Customer satisfaction is our core objective. We prioritize communication and cooperation with customers, providing personalized solutions based on their needs and ensuring timely after-sales service.

**Customer Satisfaction**

These capabilities and resources enable us to deliver high-quality, innovative, and reliable outdoor lighting solutions that meet diverse customer demands. We will continue to enhance our factory's capabilities to provide customers with even better products and services.

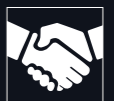



### Quality Assurance

We strictly adhere to a quality management system, implementing rigorous quality control at every stage, from raw material procurement to production. We are committed to delivering products that meet international standards and customer requirements.

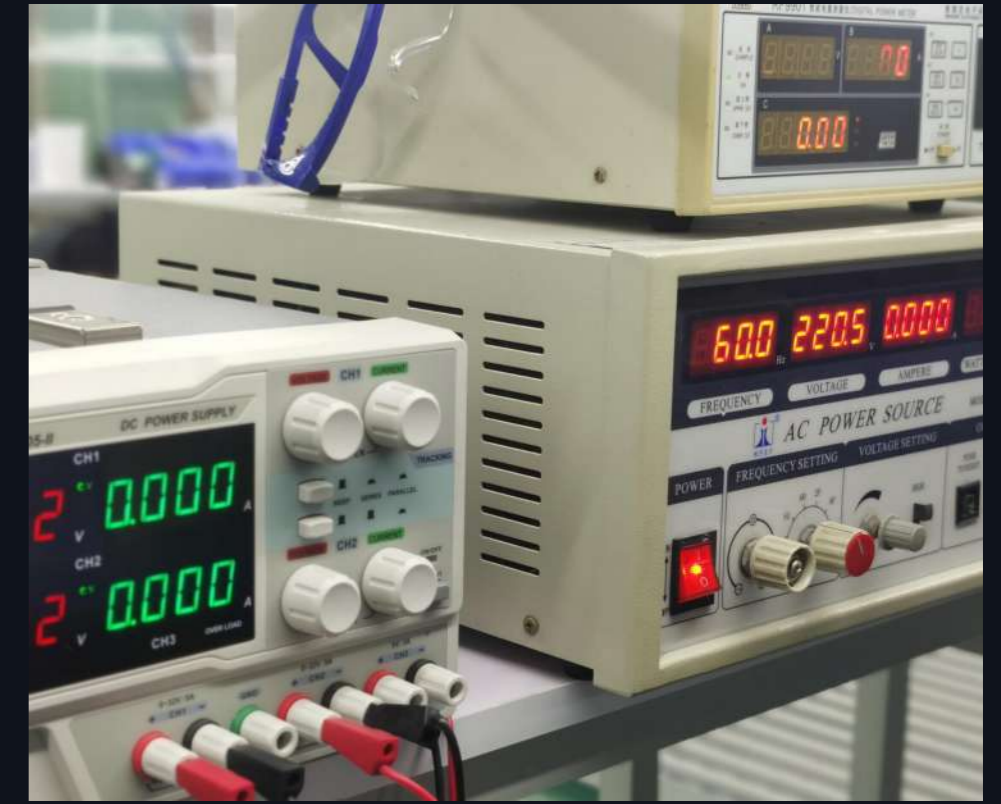

Our factory is equipped with advanced equipment and manufacturing technology, including high-precision machining equipment, automated production lines, and precise testing devices. These facilities and technologies ensure the quality and performance of our products.

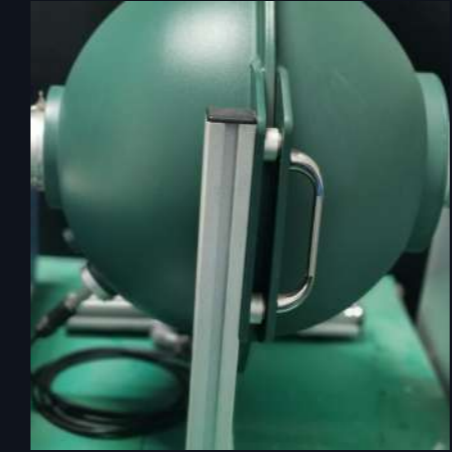

Electronic Components, Mechanical Material, Materials & Lightings Test Instrument



# Contents

Page 21-106



Outdoor In-ground Light IP67

Page 107-180



Outdoor Spot Light IP66

Page 181-208



LED Wall Light IP65

Page 209-246



Outdoor Underwater Light IP68

Page 247-284



LED Wall Washer Light IP65

Series 2 In-ground Light  
Page 4-33

NEW

Circular



P33

Square

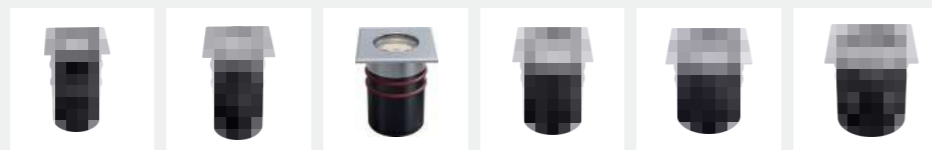

P35

Half Covered

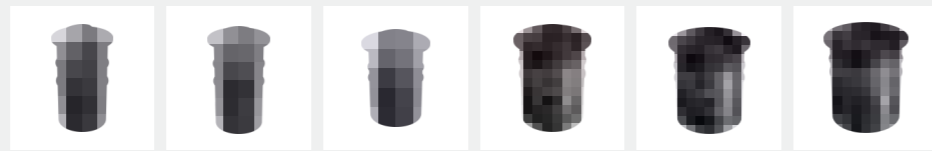

P37

Trimless

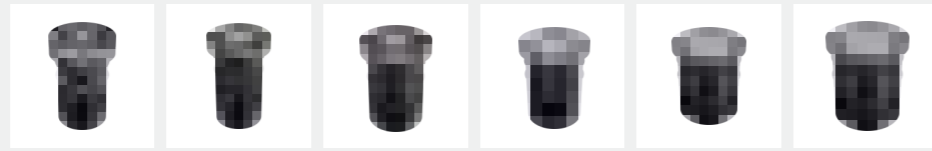

P39

Step

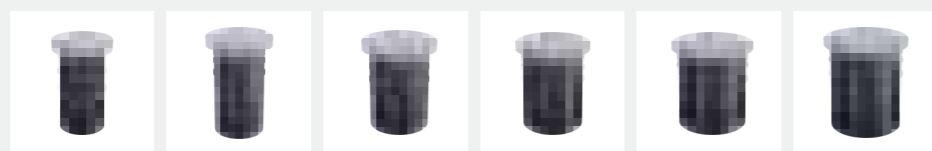

P45

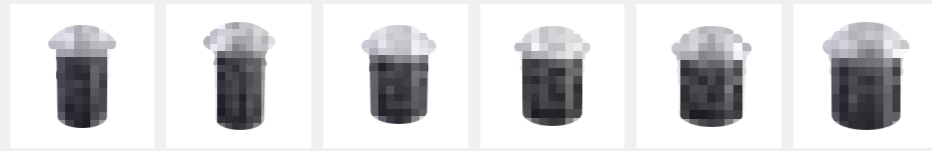

P49

LED Adjustable Inground Light  
Page4-33



P63

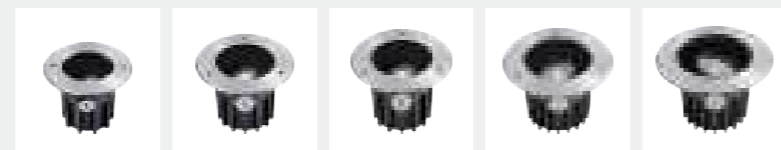

P65



P67

LED Depth Illuminant Inground Light  
Page 4-33

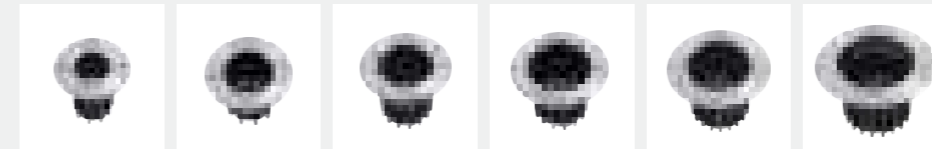

P71

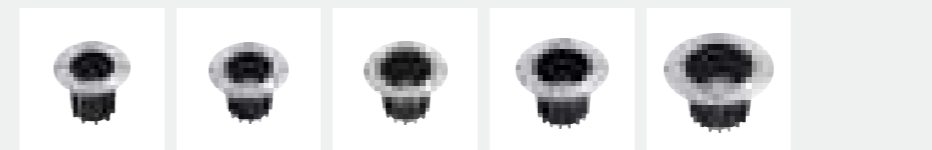

P73

Asymmetric

LED COB Inground Light  
Page 4-33

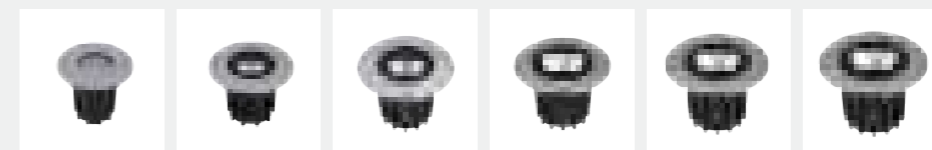

P77

Reflector

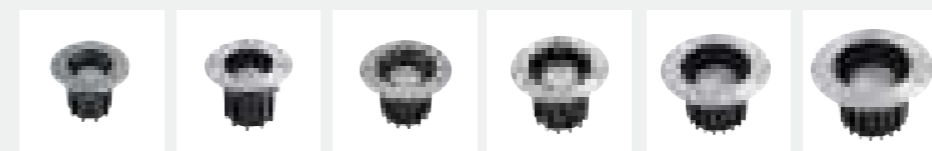

P79

LED Inground Light  
Page 4-33



P83

COB

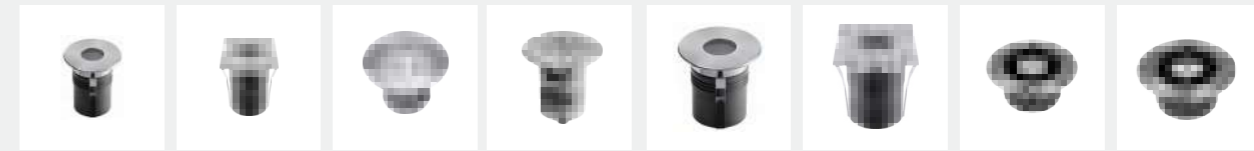

P85

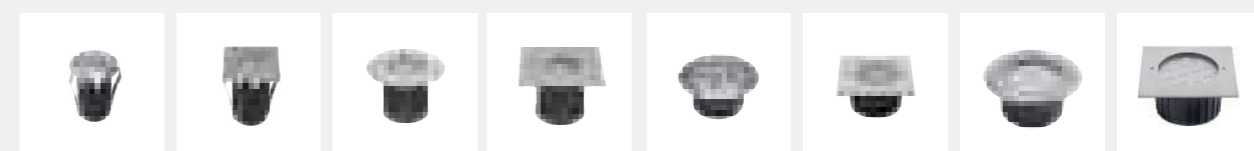

P87

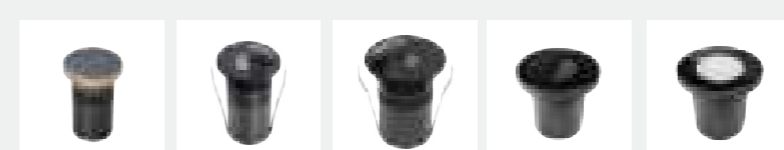

P89

Slim Type  
LED  
Inground Light  
Page 4-33



P91

LED Inground Side Light  
Page 4-33

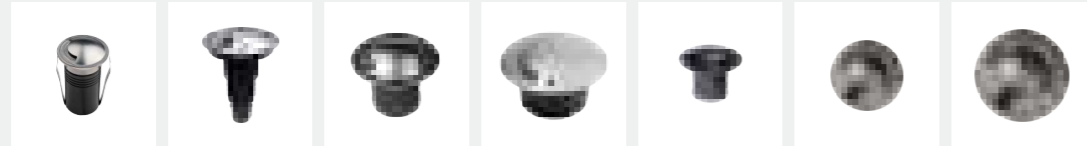

P93

LED Linear Inground Light  
Page 4-33

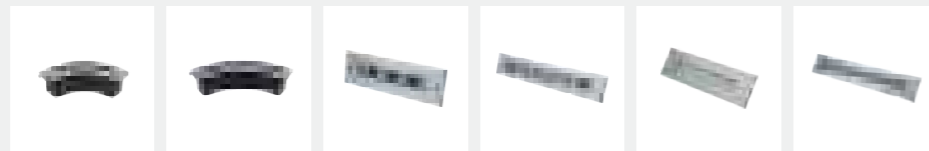

P103

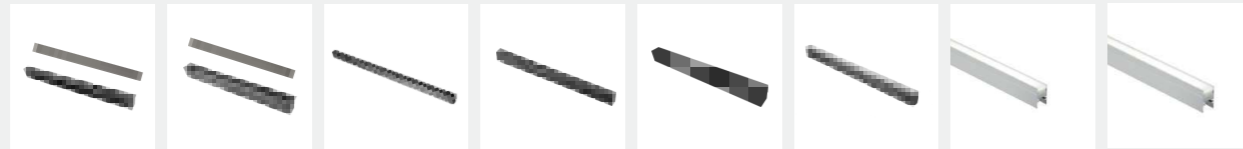

P105

Zoomable LED  
Landscape  
Spot Light  
Page 4-33

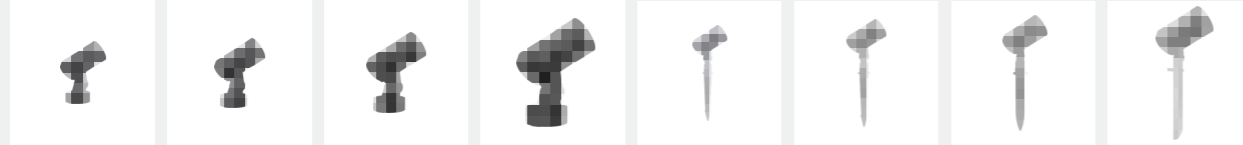

P117



P119



P121

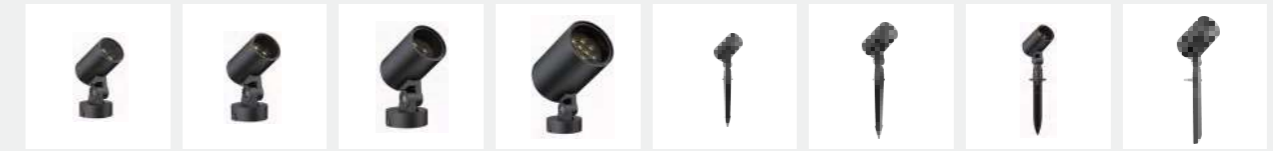

P125

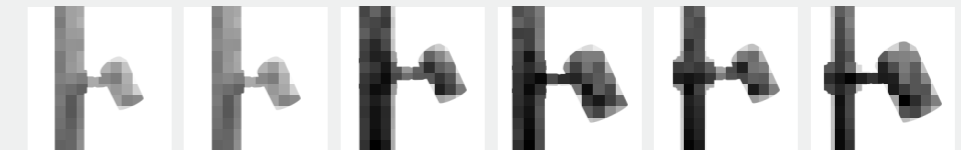

P127



P129

Round LED Landscape Spot Light --Series 3H  
Page 4-33

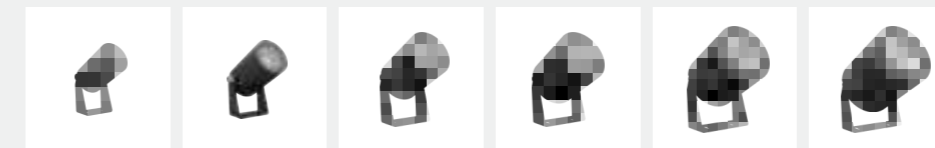

P141

NEW

Round(Slanted Hat)



P143

Round(Straight Hat)



P145

Square



P149

Square(Slanted Hat)



P151

Square(Straight Hat)



P153

LED Landscape  
Spot Light  
--Series LP  
Page 4-33

LED Landscape Spot Light  
Page 4-33



P155

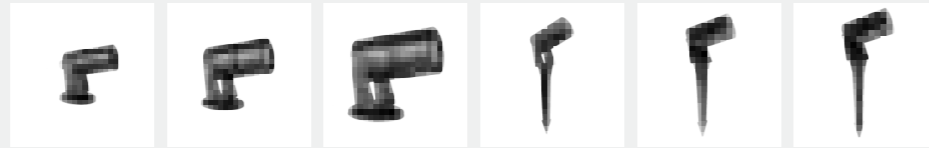

P157

LED Landscape Spot Light  
-- Series TW  
Page 4-33

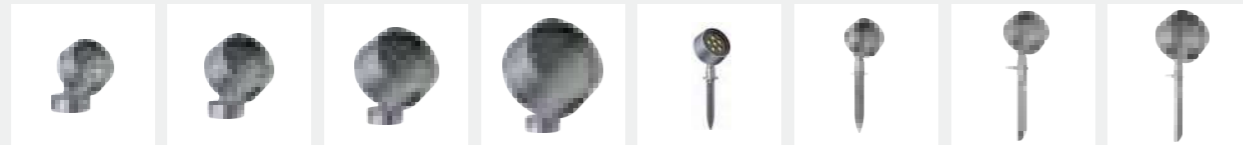

P163

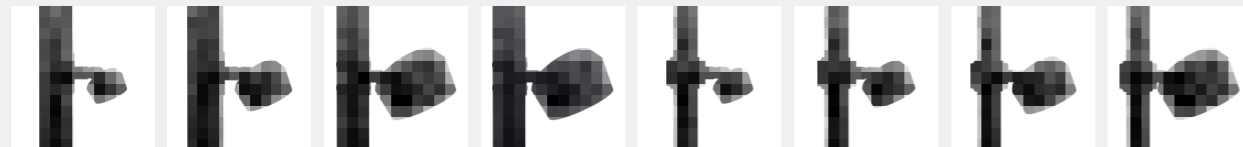

P165



P167

LED Landscape Spot Light -- Series LS  
Page 4-33



P171

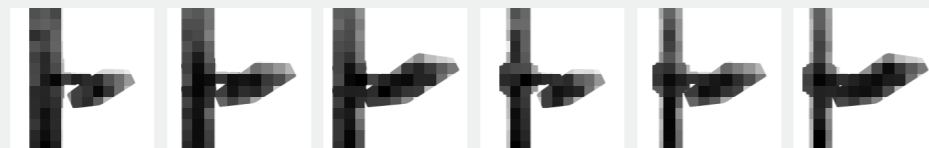

P173



P175

LED Landscape Spot Light  
Page 4-33



P177



P179

LED Wall Light  
Page 4-33



P191

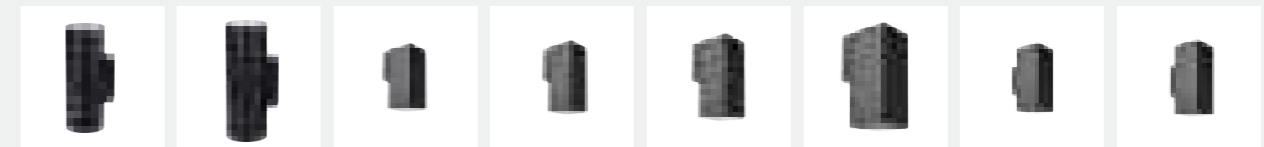

P197

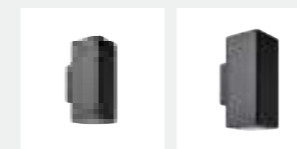

P199



P199

Recessed

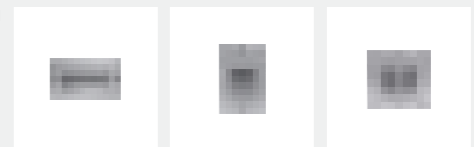

P201

LED Step Light  
Page 4-33

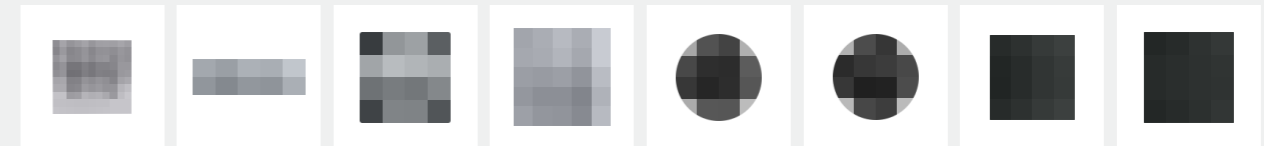

P203

LED Window Light  
Page 4-33



P205

LED Handrail Light  
Page 4-33

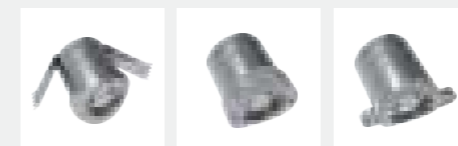

P207

LED Recessed Underwater Light  
Page 4-33



P217

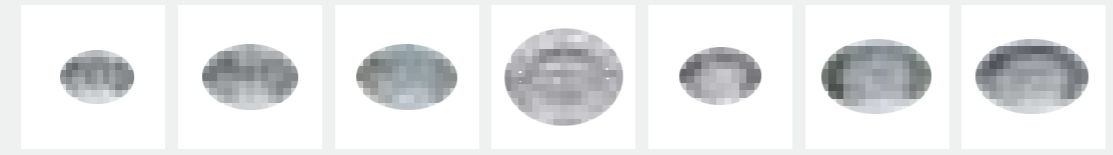

P219

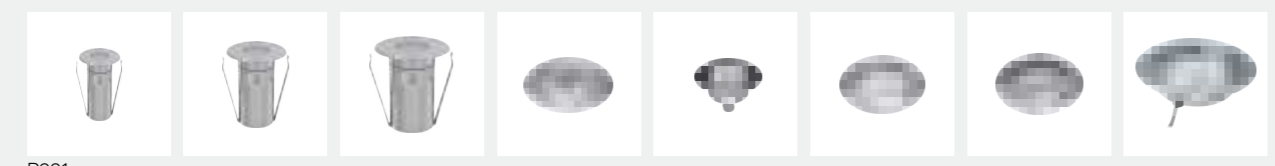

P221

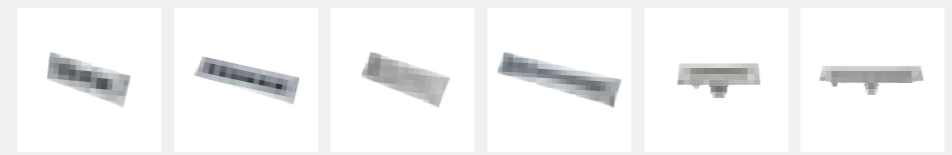

P223

LED Fountain Light  
Page 4-33

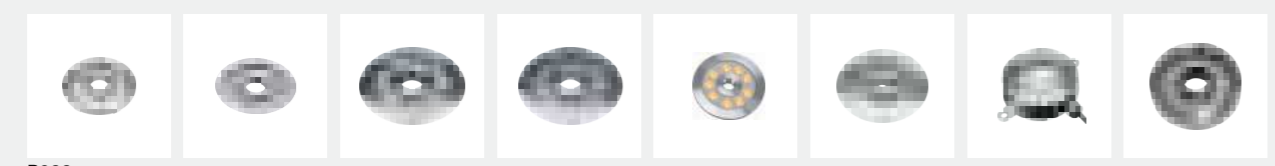

P233

LED Underwater Spot Light  
Page 4-33



P243

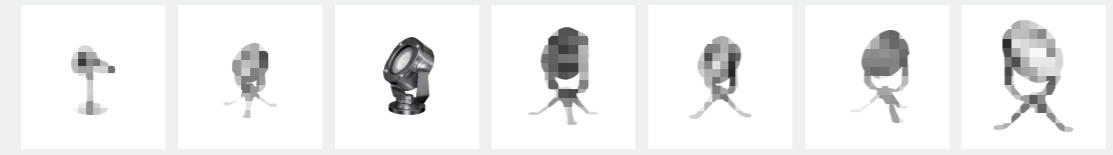

P245

LED Wall washer Light  
Page 4-33



P253



LED IP66 Ceiling Light  
Page 4-33

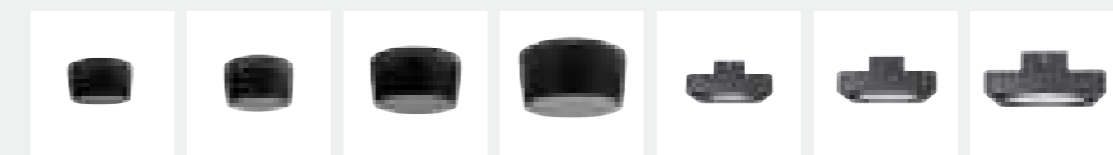

P263

LED IP67 Ceiling Light  
Page 4-33



P269

## Series 2

In-ground luminaires stands out for special housing design and high quality optical components specifically for demanding visual tasks to provide enhanced visual comfort.



**Series 2**  
New Inground Light

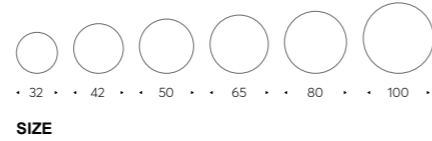

**WB Ovision**

Housing made of 12# Die-casting aluminum with Tiger powder painting and Titanium chrome white SUS 316L front ring, applicable for outdoor installation, seaside and high pH environment.

Clear tempered safety glass, transmittance of light is over 95% and the accuracy of color temperature as well as strong impact resistance bearing capacity.

Quick&simple installation with low maintenance.

Sturdy construction in order to maintain performance of the luminaire and to reduce maintenance costs.

Applicable for outdoor installation, hotel, villa, facade, garden, residential.



**PARTS ADDITION**

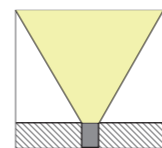

IK10 Anti-collision level

**SCENE**



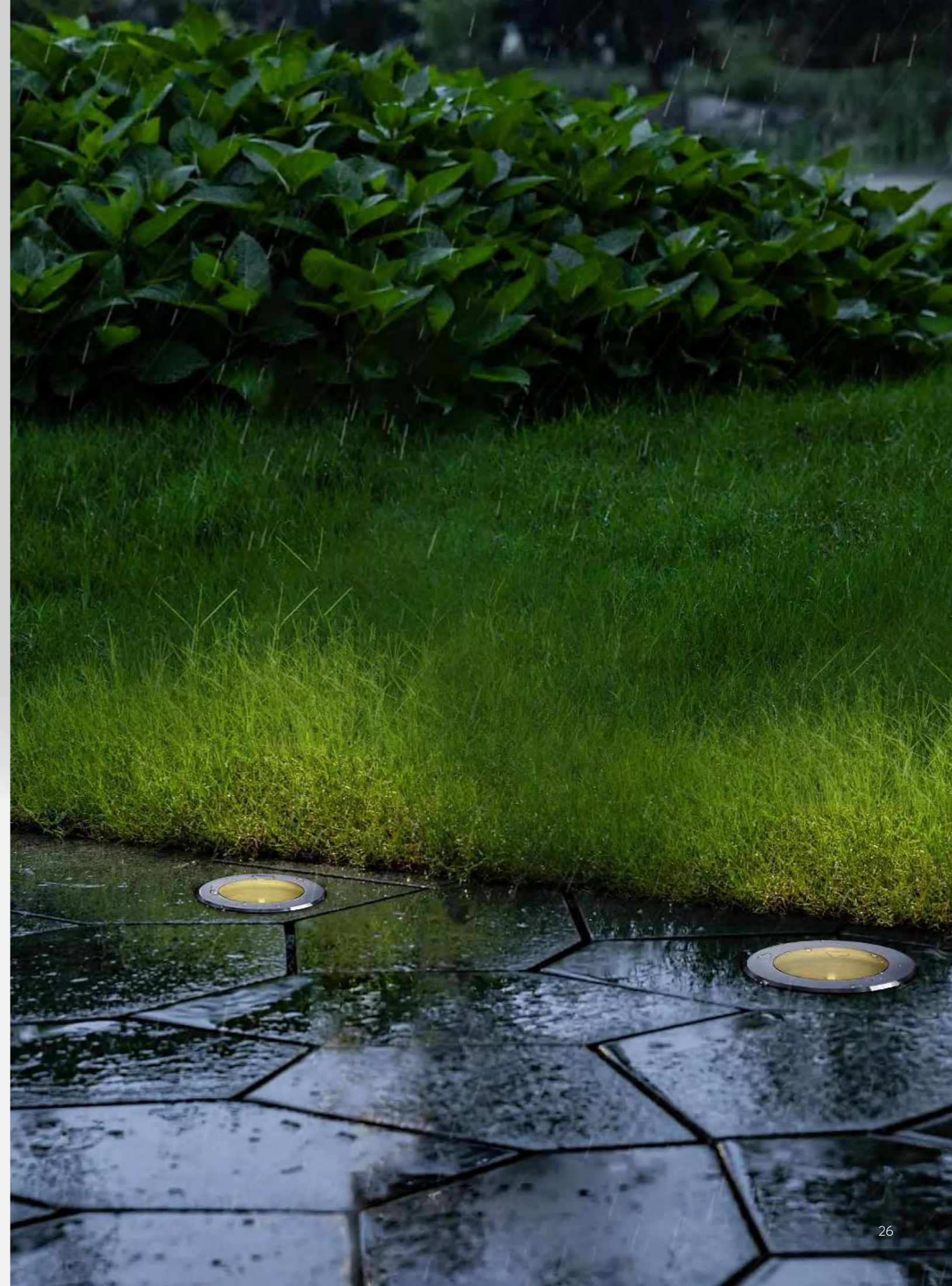

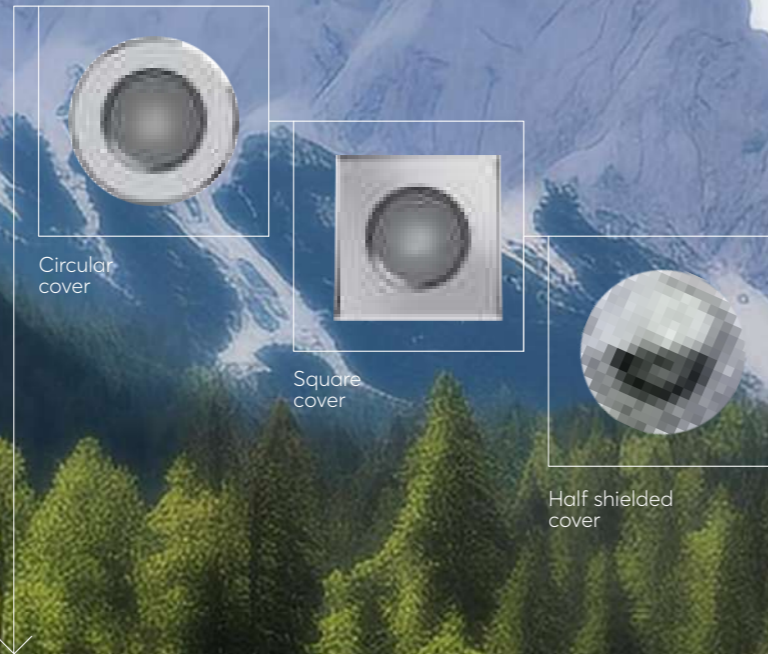

## Series 2

Corrosion-resistant die-casting aluminium body gives the luminaire good thermal conductivity, and large area connections between the rear of the housing and the led s pcb

Ensure good heat conduction.  
Stainless steel screws, high strengt  
4mm toughened glass >92% light transmittance.

Extremely narrow to wide beam options, rotationally symmetric light.  
Installation on floor  
(with mounting sleeve) and ground  
(with or without mounting sleeve).

### Series 2 Inground Light

Website: [WWW.iliteuk.com](http://WWW.iliteuk.com)  
Email: [sales@iliteuk.com](mailto:sales@iliteuk.com)  
Address: 1 Hatton Street, London, United Kingdom, NW8 8PL

## Series 2

Special face cover design and high-quality optical components, drilled for visual needs projects to provide enhanced visual effects, very suitable for non glare lighting, floodlighting in outdoor areas.

Lens



Lens  
+honeycomb



Lens  
+grille



Diffuser



Walk Over

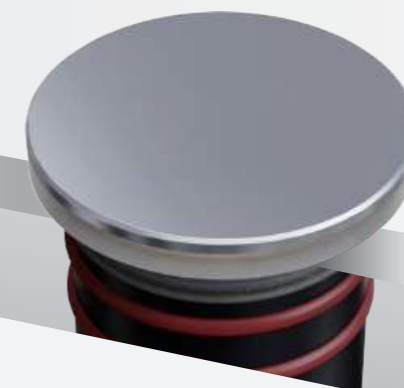

Half covered

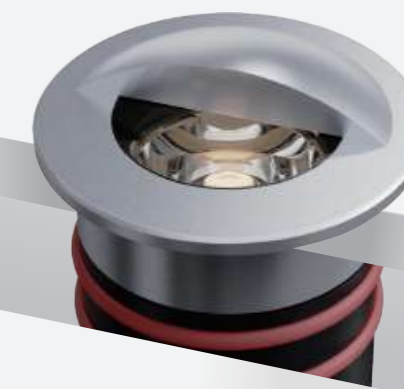

Lens  
+silk print



Trimless  
+frosted glass



Trimless  
+frosted glass  
+silk print



Walk Over  
+light sectors

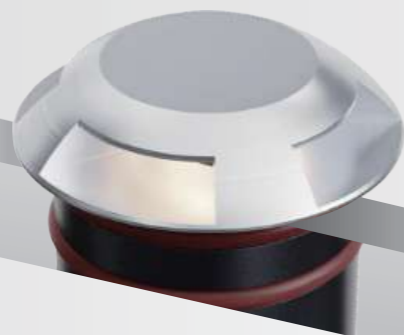



## Series 2 Inground Light

CE ErP IP67 RoHS 1-10V Triac PWM DALI RGB RGBW

### 2032R1\* $\alpha$ -A3-Y

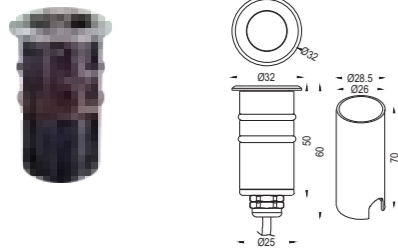

Power LED	Color	IK	Luminous	Input Voltage	Beam Angle
1*2W CREE XPE/OSRAM 3030	Steel	IK10	--	12/24VDC	5°/10°/15°/20°/30°/40°/60°/10°/45°/25°/45°



### 2065R1\* $\alpha$ -B3-Y

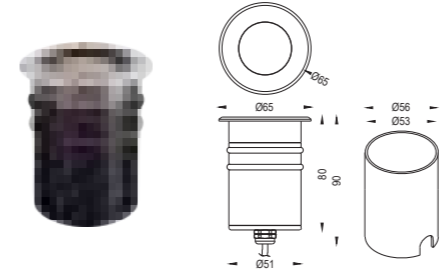

Power LED	Color	IK	Luminous	Input Voltage	Beam Angle
1*6.5W CREE 1512	Steel	IK08	720LM	12/24VDC 220-240VAC	12°/24°/36°/55°



### 2042R1\* $\alpha$ -B3-Y

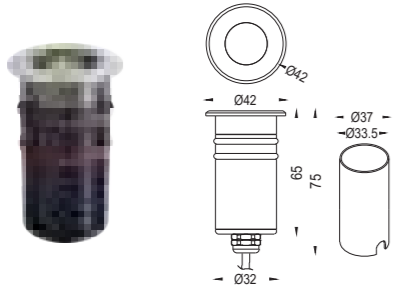

Power LED	Color	IK	Luminous	Input Voltage	Beam Angle
1*4W CREE 1304	Steel	IK08	340LM	12/24VDC 220-240VAC	15°/24°/36°/55°



### 2080R1\* $\alpha$ -B3-Y

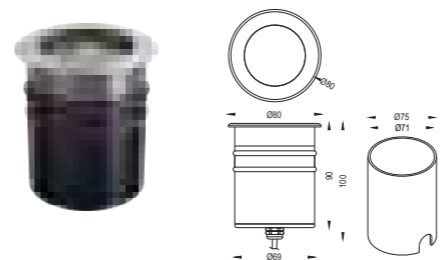

Power LED	Color	IK	Luminous	Input Voltage	Beam Angle
1*10W CREE 1512	Steel	IK08	900LM	12/24VDC 220-240VAC	12°/24°/36°/55°



### 2050R1\* $\beta$ -B3-Y

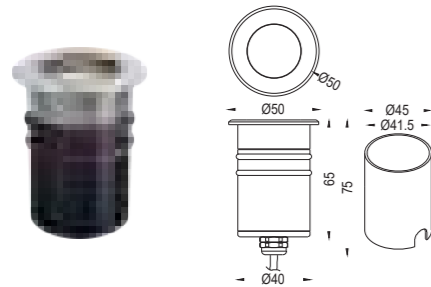

Power LED	Color	IK	Luminous	Input Voltage	Beam Angle
1*4.5W CREE 1304	Steel	IK08	454LM	12/24VDC 220-240VAC	12°/24°/36°/55°



### 2100R1\* $\alpha$ -B3-Y



Power LED	Color	IK	Luminous	Input Voltage	Beam Angle
1*15W CREE 1512	Steel	IK08	900LM	12/24VDC 220-240VAC	12°/24°/36°/55°



## Series 2 Inground Light

CE ErP IP67 RoHS 1-10V Triac PWM DALI RGB RGBW

### 2032S1\*α-A3-Y

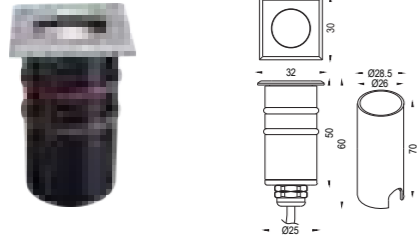

Power LED	Color	IK	Luminous	Input Voltage	Beam Angle
1*2W CREE XPE/OSRAM 3030	Steel	IK10	--	12/24VDC	5°/10°/15°/20°/30°/40°/60°/10°/45°/25°/45°



### 2065S1\*α-B3-Y

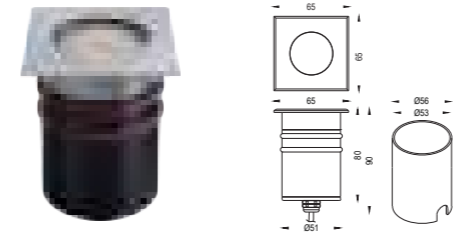

Power LED	Color	IK	Luminous	Input Voltage	Beam Angle
1*6.5W CREE 1512	Steel	IK08	720LM	12/24VDC 220-240VAC	12°/24°/36°/55°



### 2042S1\*α-B3-Y

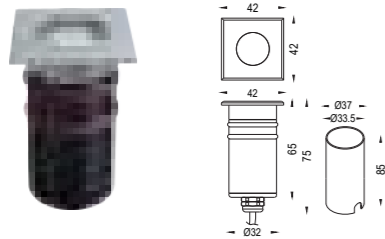

Power LED	Color	IK	Luminous	Input Voltage	Beam Angle
1*4W CREE 1304	Steel	IK08	340LM	12/24VDC 220-240VAC	15°/24°/36°/55°



### 2080S1\*α-B3-Y

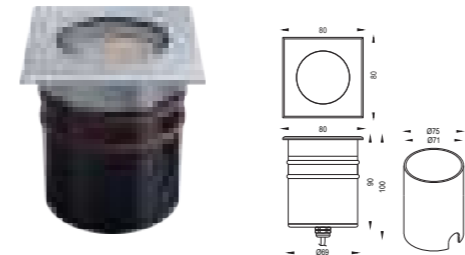

Power LED	Color	IK	Luminous	Input Voltage	Beam Angle
1*10W CREE 1512	Steel	IK08	900LM	12/24VDC 220-240VAC	12°/24°/36°/55°



### 2050S1\*b-B3-Y



Power LED	Color	IK	Luminous	Input Voltage	Beam Angle
1*4.5W CREE 1304	Steel	IK08	454LM	12/24VDC 220-240VAC	12°/24°/36°/55°



### 2100S1\*α-B3-Y

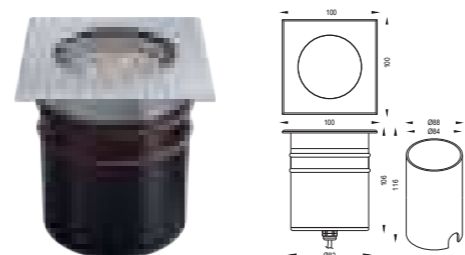

Power LED	Color	IK	Luminous	Input Voltage	Beam Angle
1*15W CREE 1512	Steel	IK08	900LM	12/24VDC 220-240VAC	12°/24°/36°/55°



## Series 2 Inground Light -- Half Covered



### 2032R5\* $\alpha$ -A3-Y

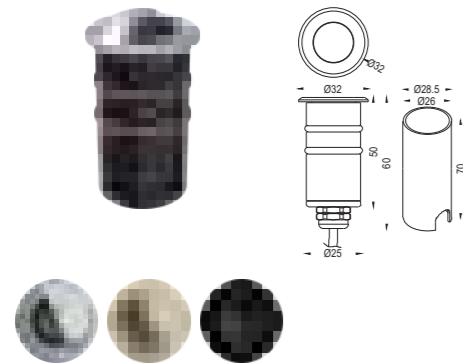

Power LED	Color	IK	Luminous	Input Voltage	Beam Angle
1*2W CREE XPE/OSRAM 3030	Steel	IK10	--	12/24VDC	5°/10°/15°/20°/30°/40°/60°/10°/45°/25°/45°



### 2065R5\* $\alpha$ -B3-Y



Power LED	Color	IK	Luminous	Input Voltage	Beam Angle
1*6.5W CREE 1512	Black	IK08	720LM	12/24VDC 220-240VAC	12°/24°/36°/55°



### 2042R5\* $\alpha$ -B3-Y

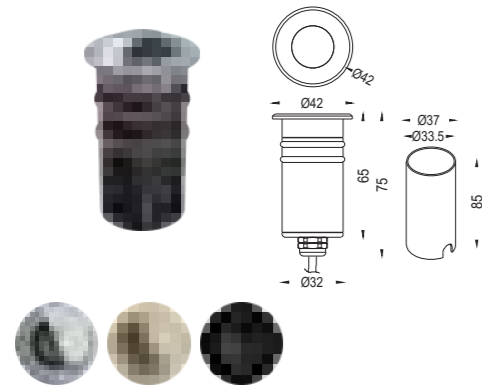

Power LED	Color	IK	Luminous	Input Voltage	Beam Angle
1*4W CREE 1304	Steel	IK08	340LM	12/24VDC 220-240VAC	15°/24°/36°/55°



### 2080R5\* $\alpha$ -B3-Y



Power LED	Color	IK	Luminous	Input Voltage	Beam Angle
1*10W CREE 1512	Black	IK08	900LM	12/24VDC 220-240VAC	12°/24°/36°/55°



### 2050R5\* $\beta$ -B3-Y

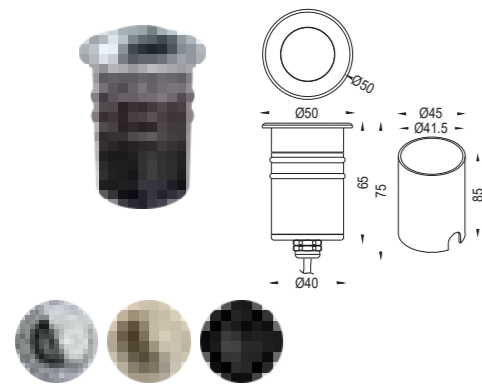

Power LED	Color	IK	Luminous	Input Voltage	Beam Angle
1*4.5W CREE 1304	Steel	IK08	454LM	12/24VDC 220-240VAC	12°/24°/36°/55°



### 2100R5\* $\alpha$ -B3-Y



Power LED	Color	IK	Luminous	Input Voltage	Beam Angle
1*15W CREE 1512	Black	IK08	900LM	12/24VDC 220-240VAC	12°/24°/36°/55°



## Series 2 Inground Light -- Trimless



### 2032R2\* $\alpha$ -A3-Y

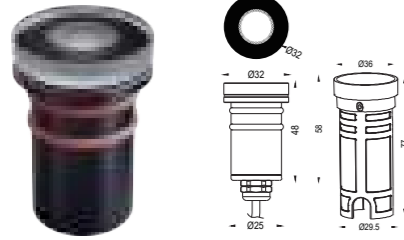

Power LED	Color	IK	Luminous	Input Voltage	Beam Angle
1*2W CREE XPE/OSRAM 3030	Steel	IK10	--	12/24VDC	5°/10°/15°/20°/30°/40°/60°/10°/45°/25°/45°



### 2065R2\* $\alpha$ -B3-Y



Power LED	Color	IK	Luminous	Input Voltage	Beam Angle
1*6.5W CREE 1512	Steel	IK08	720LM	12/24VDC 220-240VAC	12°/24°/36°/55°



### 2042R2\* $\alpha$ -B3-Y

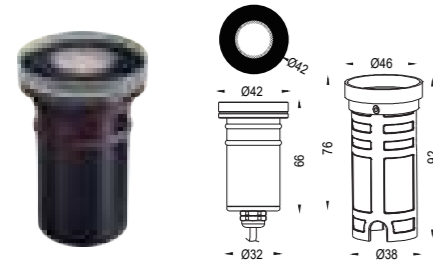

Power LED	Color	IK	Luminous	Input Voltage	Beam Angle
1*4W CREE 1304	Steel	IK08	340LM	12/24VDC 220-240VAC	15°/24°/36°/55°



### 2080R2\* $\alpha$ -B3-Y



Power LED	Color	IK	Luminous	Input Voltage	Beam Angle
1*10W CREE 1512	Steel	IK08	900LM	12/24VDC 220-240VAC	12°/24°/36°/55°



### 2050R2\* $\beta$ -B3-Y

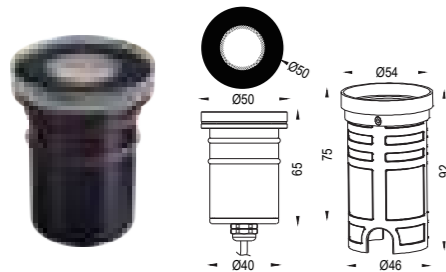

Power LED	Color	IK	Luminous	Input Voltage	Beam Angle
1*4.5W CREE 1304	Steel	IK08	454LM	12/24VDC 220-240VAC	12°/24°/36°/55°



### 2100R2\* $\alpha$ -B3-Y



Power LED	Color	IK	Luminous	Input Voltage	Beam Angle
1*15W CREE 1512	Steel	IK08	900LM	12/24VDC 220-240VAC	12°/24°/36°/55°



## Walk Over

Quick&simple installation with low maintenance.

Sturdy construction in order to maintain performance of the luminaire and to reduce maintenance costs.

Applicable for outdoor installation, hotel,villa,facade, garden, residential.



Series 2 Inground Light -- Walk Over

Website: [WWW.iliteuk.com](http://WWW.iliteuk.com)

Email: [sales@iliteuk.com](mailto:sales@iliteuk.com)

Address: 1 Hatton Street, London, United Kingdom, NW8 8PL



Series 2 Inground Light -- Walk Over

Website: [WWW.iliteuk.com](http://WWW.iliteuk.com)  
Email: [sales@iliteuk.com](mailto:sales@iliteuk.com)  
Address: 1 Hatton Street, London, United Kingdom, NW8 8PL

## Series 2 Inground Light -- Walk Over

CE ErP IP67 RoHS 1-10V Triac PWM DALI RGB RGBW

### 2032R7\*α-A3-Y

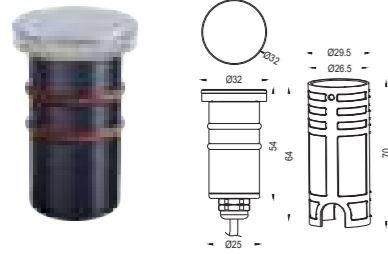

Power LED	Color	IK	Luminous	Input Voltage	Beam Angle
1*2W CREE XPE/OSRAM 3030	Steel	IK10	--	12/24VDC	360°



### 2065R7\*α-B3-Y



Power LED	Color	IK	Luminous	Input Voltage	Beam Angle
1*6.5W CREE 1512	Steel	IK08	--	12/24VDC 220-240VAC	360°



### 2042R7\*α-B3-Y

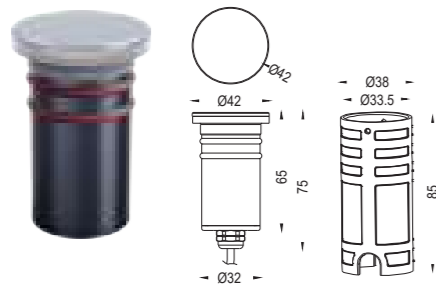

Power LED	Color	IK	Luminous	Input Voltage	Beam Angle
1*4W CREE 1304	Steel	IK08	--	12/24VDC 220-240VAC	360°



### 2080R7\*α-B3-Y

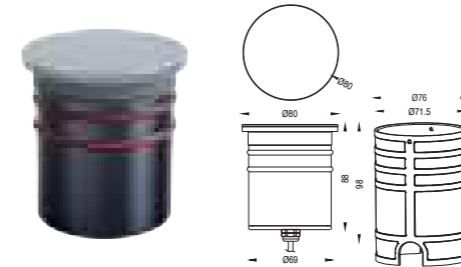

Power LED	Color	IK	Luminous	Input Voltage	Beam Angle
1*10W CREE 1512	Steel	IK08	--	12/24VDC 220-240VAC	360°



### 2050R7\*α-B3-Y



Power LED	Color	IK	Luminous	Input Voltage	Beam Angle
1*4.5W CREE 1304	Steel	IK08	--	12/24VDC 220-240VAC	360°



### 2100R7\*α-B3-Y



Power LED	Color	IK	Luminous	Input Voltage	Beam Angle
1*15W CREE 1512	Steel	IK08	--	12/24VDC 220-240VAC	360°





Series 2 Inground Light -- Walk Over

Website: [WWW.iliteuk.com](http://WWW.iliteuk.com)  
Email: [sales@iliteuk.com](mailto:sales@iliteuk.com)  
Address: 1 Hatton Street, London, United Kingdom, NW8 8PL

## Series 2 Inground Light -- Walk Over

CE ERP IP67 RoHS 1-10V Triac PWM DALI DMX RGB RGBW

### 2032R7\*b-A3-Y-1way/2way/4way

Power LED	Color	IK	Luminous	Input Voltage	Beam Angle
1*2W CREE XPE/OSRAM 3030	Steel	IK10	--	12/24VDC	1/2/4way

### 2065R7\*b-B3-Y-1way/2way/4way

Power LED	Color	IK	Luminous	Input Voltage	Beam Angle
1*6.5W CREE 1512	Steel	IK08	--	12/24VDC 220-240VAC	1/2/4way

### 2042R7\*b-B3-Y-1way/2way/4way

Power LED	Color	IK	Luminous	Input Voltage	Beam Angle
1*4W CREE 1304	Steel	IK08	--	12/24VDC 220-240VAC	1/2/4way

### 2080R7\*b-B3-Y-1way/2way/4way

Power LED	Color	IK	Luminous	Input Voltage	Beam Angle
1*10W CREE 1512	Steel	IK08	--	12/24VDC 220-240VAC	1/2/4way

### 2050R7\*b-B3-Y-1way/2way/4way

Power LED	Color	IK	Luminous	Input Voltage	Beam Angle
1*4.5W CREE 1304	Steel	IK08	--	12/24VDC 220-240VAC	1/2/4way

### 2100R7\*b-B3-Y-1way/2way/4way

Power LED	Color	IK	Luminous	Input Voltage	Beam Angle
1*15W CREE 1512	Steel	IK08	--	12/24VDC 220-240VAC	1/2/4way

## LED Inground Light

Housing made of 12# Die-casting aluminum with Tiger powder painting and Titanium chrome white SUS 316L front ring, applicable for outdoor installation, seaside and high pH environment.

Clear tempered safety glass, transmittance of light is over 95% and the accuracy of color temperature as well as strong impact resistance bearing capacity.



**Beam Direction  
Adjustable  
In-ground Light**

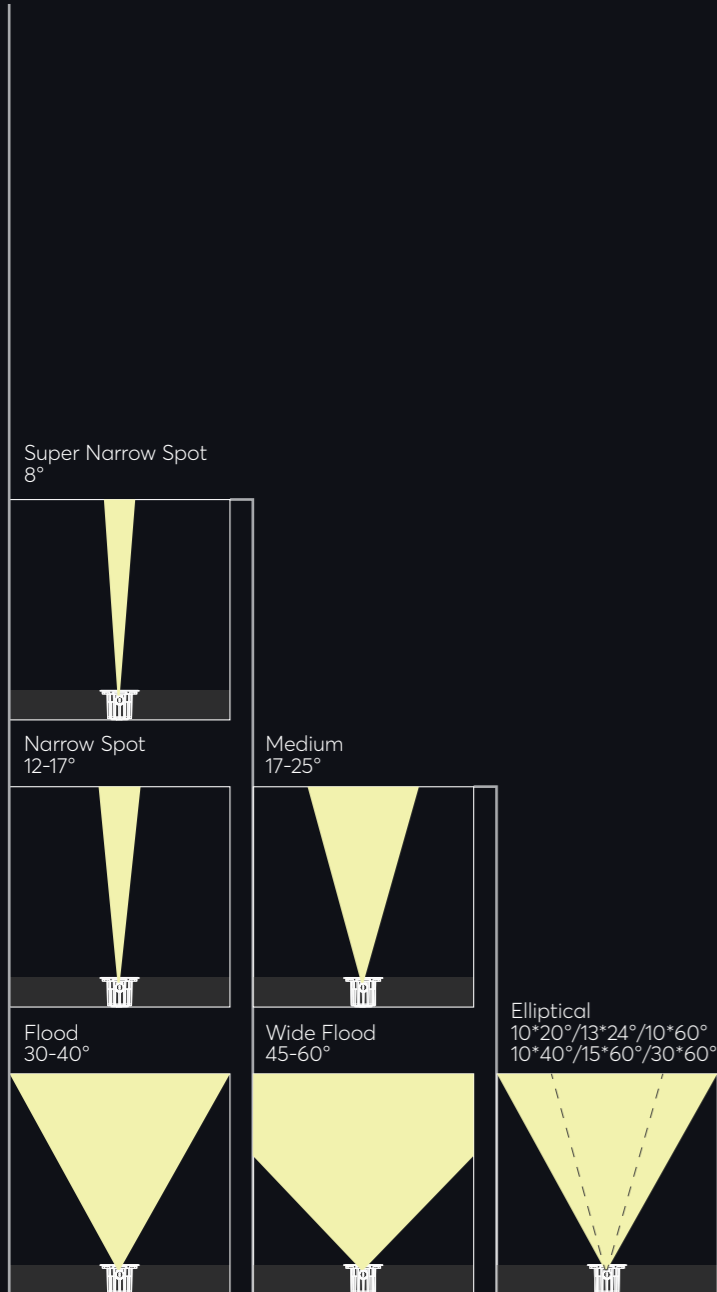



Uplights

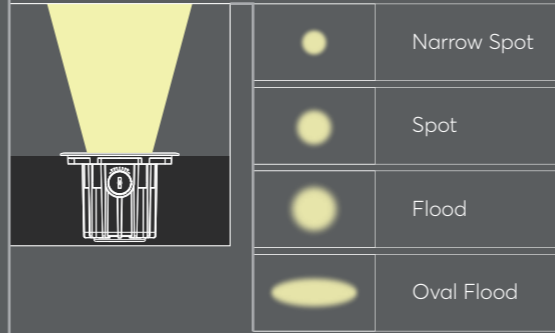

Uplights for precise grazing light on facades or objects.

Lens Wallwasher

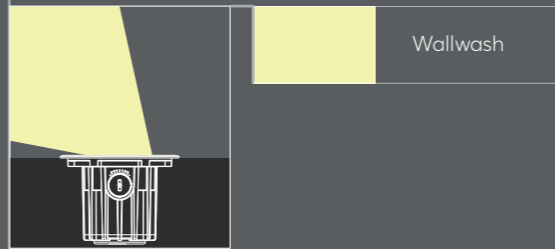

Lens wallwashers for an exceptionally uniform brightness distribution on vertical surfaces.

Directional Luminaires

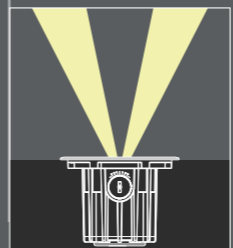

Asymmetrical light distribution for accent lighting.

## Series AY

30 degree adjustable in clockwise or anti-clockwise, 0/10/20/30 graduations for beam direction adjustability.

Make the light beam at the most reasonable direction toward the illuminated objects.



Series AY Inground Light

Website: [WWW.iliteuk.com](http://WWW.iliteuk.com)

Email: [sales@iliteuk.com](mailto:sales@iliteuk.com)

Address: 1 Hatton Street, London, United Kingdom, NW8 8PL

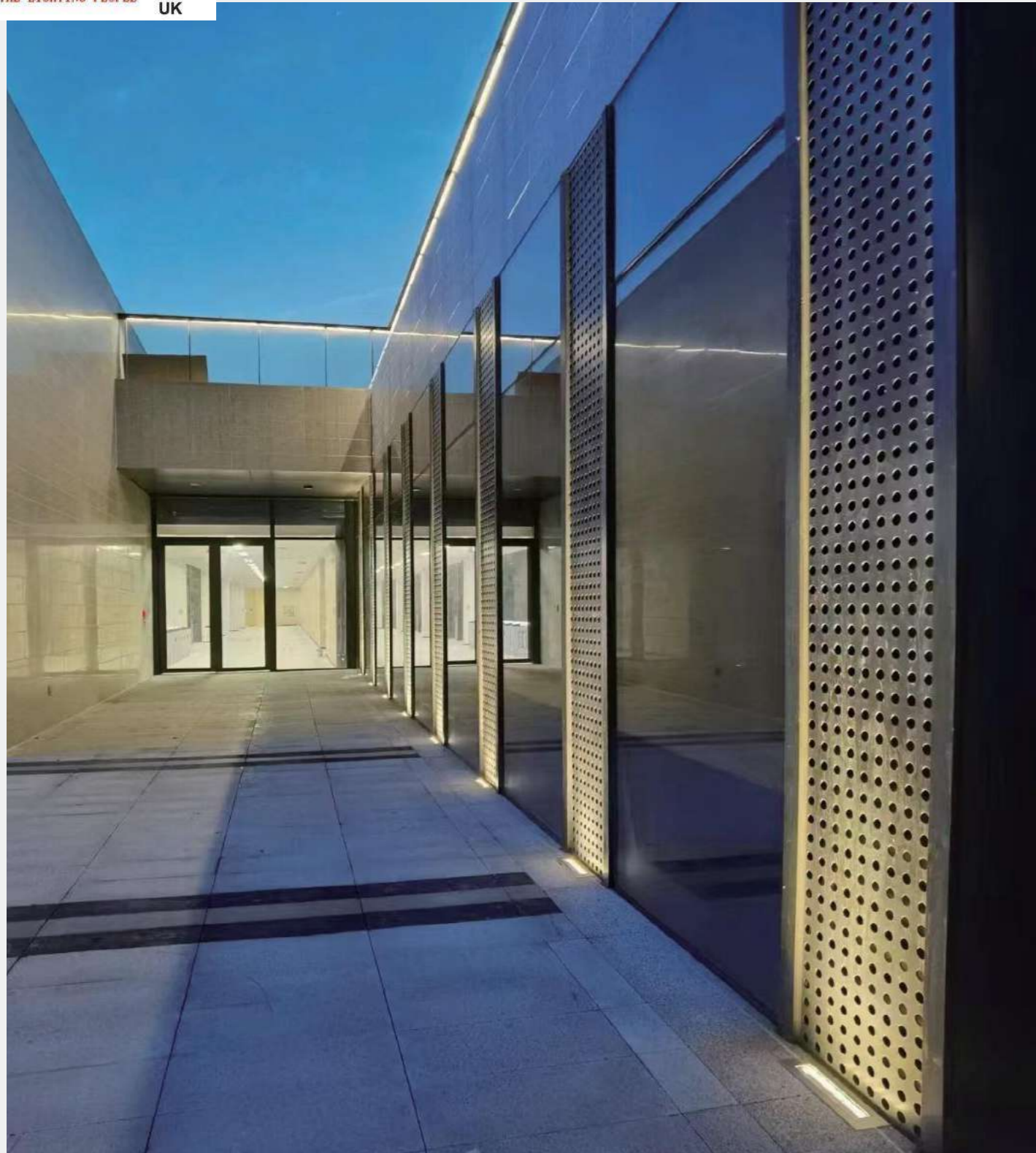

**Specialized in LED Outdoor Light**

In-ground luminaires stands out for special housing design and high quality optical components

specifically for demanding visual tasks to provide enhanced visual comfort.

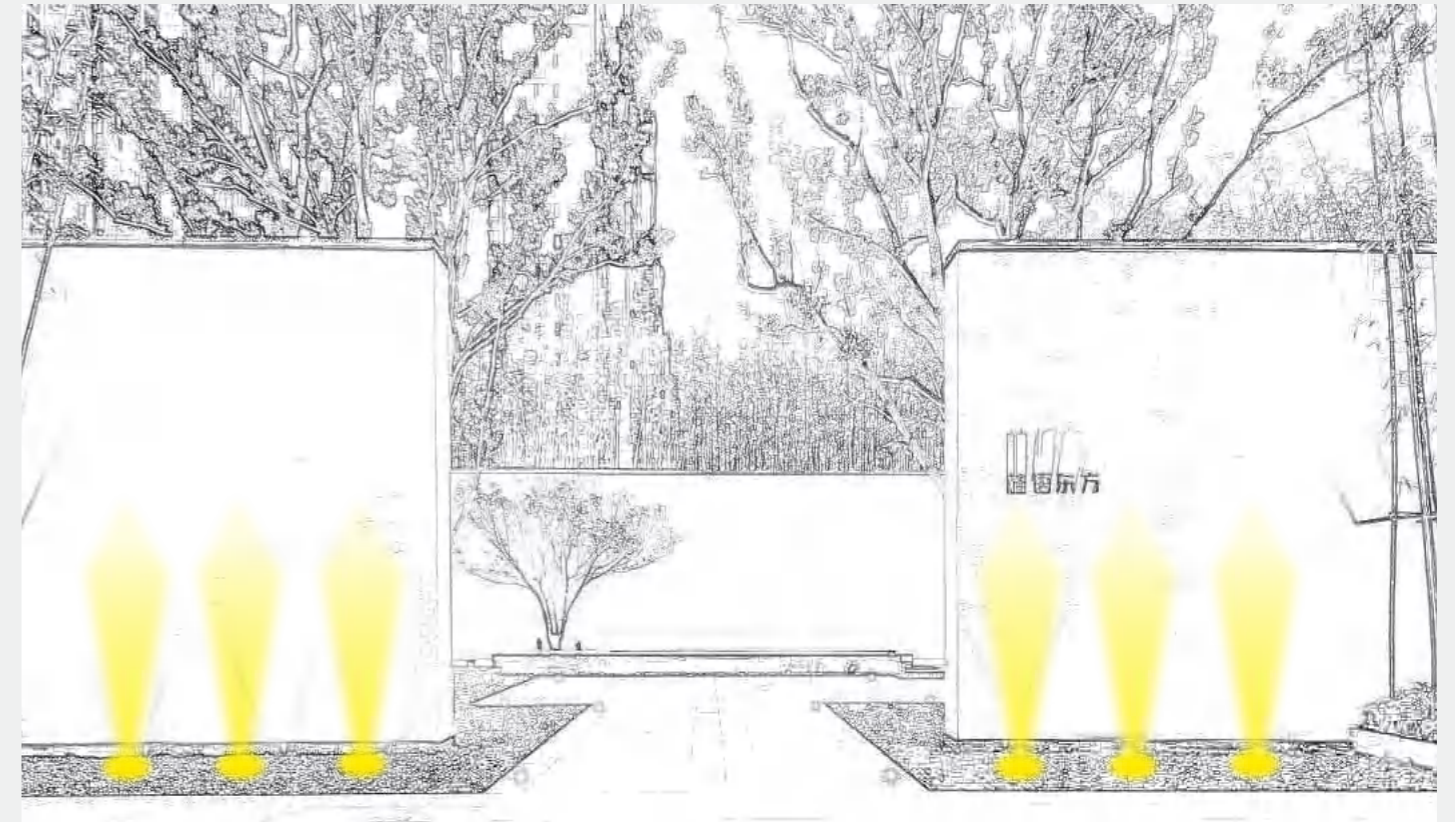

**Material Quality**

12# Die-casting powder coated aluminum housing  
Titanium chrome white SUS 316L front cover  
Tempered glass.

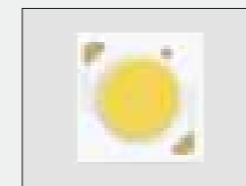

**LED**

CREE/OSRAM/BRIDGELUX, CRI>80(CRI>90 on request)  
Cable 0.5m  
ABS Mounting sleeve



**Quality/Supporting**

IP67 IK10  
Life time ≥50000 hrs  
Operating temperature -20 C ~40 C

The external light direction of the lamp can be adjusted at around 25 degrees, and the unique spherical heat dissipation structure is adopted to ensure sufficient heat dissipation of the LED, so that the lamp can achieve a long service life.



## LED Adjustable Inground Light



### 2095R1\*b-A1-Y

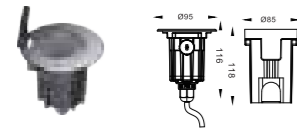

Power	LED	CCT	IK	Luminous	Input Voltage	Beam Angle
1x2W	OSRAM/CREE	Single	IK10	157lm	12/24 VDC/220-240VAC	5°/8°/15°/25°/40°/60°/10°/45°/20°/65°
1x3W	OSRAM	RGB 3in 1	IK10	60lm	12/24 VDC	12°/25°/40°/60°
1x4W	OSRAM	RGBW 4in 1	IK10	80lm	12/24 VDC	12°/25°/40°/60°

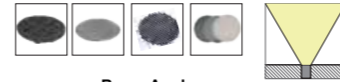

### 2210R1\*b-X1-Y-XX

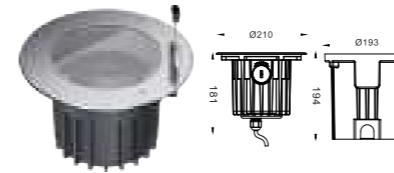

Power	LED	CCT	IK	Luminous	Input Voltage	Beam Angle
9x3W	CREE	Single	IK10	1800lm	12/24 VDC/220-240VAC	3°/8°
12x2W	OSRAM/CREE	Single	IK10	1850lm	12/24 VDC/220-240VAC	15°/25°/40°/60°/10°/45°/20°/65°
9x2.5W	OSRAM	RGB 3in 1	IK10	730lm	12/24 VDC	12°/25°/40°/60°
9x3.5W	OSRAM	RGBW 4in 1	IK10	978lm	12/24 VDC	12°/25°/40°/60°

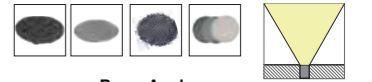

### 2130R1\*b-X1-Y-XX

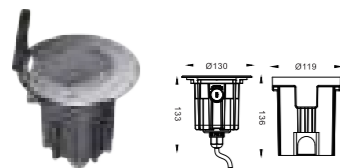

Power	LED	CCT	IK	Luminous	Input Voltage	Beam Angle
2x3W	CREE	Single	IK10	465lm	12/24 VDC/220-240VAC	3°/8°
3x2W	OSRAM/CREE	Single	IK10	465lm	12/24 VDC/220-240VAC	15°/25°/40°/60°/10°/45°/20°/65°
2x3W	OSRAM	RGB 3in 1	IK10	135lm	12/24 VDC	12°/25°/40°/60°
2x4W	OSRAM	RGBW 4in 1	IK10	182lm	12/24 VDC	12°/25°/40°/60°

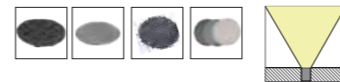

### 2250R1\*b-X1-Y-XX

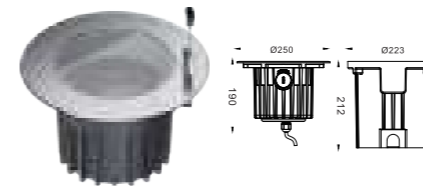

Power	LED	CCT	IK	Luminous	Input Voltage	Beam Angle
12x3W	CREE	Single	IK10	2800lm	12/24 VDC/220-240VAC	3°/8°
18x2W	OSRAM/CREE	Single	IK10	2800lm	12/24 VDC/220-240VAC	15°/25°/40°/60°/10°/45°/20°/65°
12x3W	OSRAM	RGB 3in 1	IK10	825lm	12/24 VDC	12°/25°/40°/60°
12x4W	OSRAM	RGBW 4in 1	IK10	1100lm	12/24 VDC	12°/25°/40°/60°

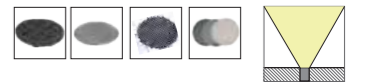

### 2160R1\*b-X1-Y-XX

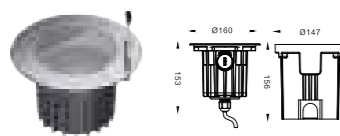

Power	LED	CCT	IK	Luminous	Input Voltage	Beam Angle
4x3W	CREE	Single	IK10	920lm	12/24 VDC/220-240VAC	3°/8°
6x2W	OSRAM/CREE	Single	IK10	920lm	12/24 VDC/220-240VAC	15°/25°/40°/60°/10°/45°/20°/65°
4x2.5W	OSRAM	RGB 3in 1	IK10	250lm	12/24 VDC	12°/25°/40°/60°
4x3.5W	OSRAM	RGBW 4in 1	IK10	430lm	12/24 VDC	12°/25°/40°/60°

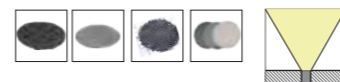

### 2180R1\*b-X1-Y-XX

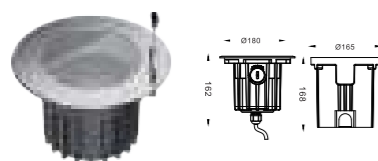

Power	LED	CCT	IK	Luminous	Input Voltage	Beam Angle
6x3W	CREE	Single	IK10	1310lm	12/24 VDC/220-240VAC	3°/8°
9x2W	OSRAM/CREE	Single	IK10	1310lm	12/24 VDC/220-240VAC	15°/25°/40°/60°/10°/45°/20°/65°
6x2.5W	OSRAM	RGB 3in 1	IK10	425lm	12/24 VDC	12°/25°/40°/60°
6x3.5W	OSRAM	RGBW 4in 1	IK10	568lm	12/24 VDC	12°/25°/40°/60°

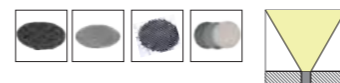

### Angle Adjustment Diagram

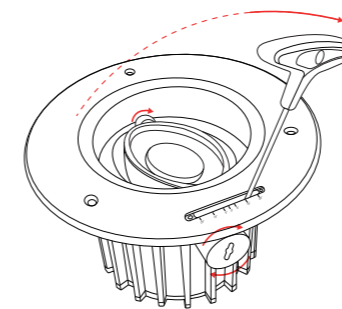

Adjust to the angle you want

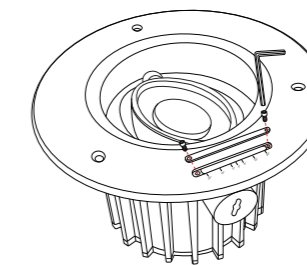

Install the stainless steel small cover plate

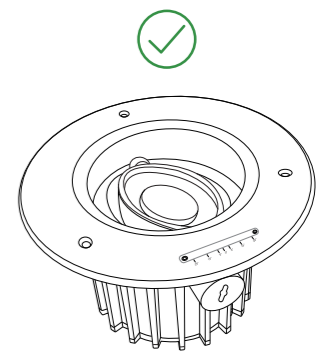

Tighten the screws to complete

## LED Adjustable Inground Light



### 2130R1\*α-B1-Y

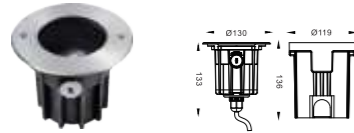

Power	LED	CCT	IK	Luminous	Input Voltage	Beam Angle
1x6W	CREE COB	Single	IK10	465lm	12/24 VDC/220-240VAC	18°/24°/38°/60°



### 2250R1\*α-B1-Y



Power	LED	CCT	IK	Luminous	Input Voltage	Beam Angle
1x36W	CREE COB	Single	IK10	2986lm	12/24 VDC/220-240VAC	18°/24°/38°/60°



### 2160R1\*α-B1-Y

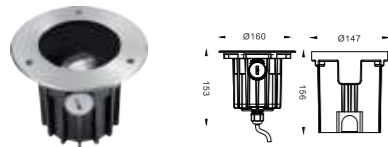

Power	LED	CCT	IK	Luminous	Input Voltage	Beam Angle
1x12W	CREE COB	Single	IK10	1120lm	12/24 VDC/220-240VAC	18°/24°/38°/60°



### 2180R1\*α-B1-Y

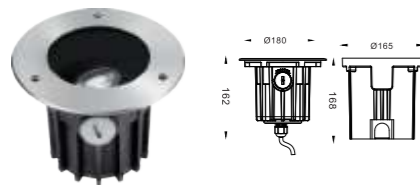

Power	LED	CCT	IK	Luminous	Input Voltage	Beam Angle
1x20W	CREE COB	Single	IK10	1438lm	12/24 VDC/220-240VAC	18°/24°/38°/60°

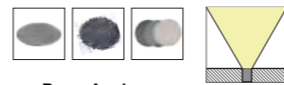

### 2210R1\*α-B1-Y

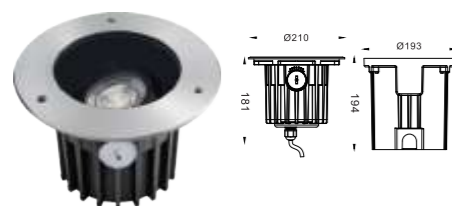

Power	LED	CCT	IK	Luminous	Input Voltage	Beam Angle
1x25W	CREE COB	Single	IK10	2130lm	12/24 VDC/220-240VAC	18°/24°/38°/60°

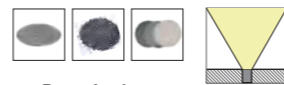

### Angle Adjustment Diagram

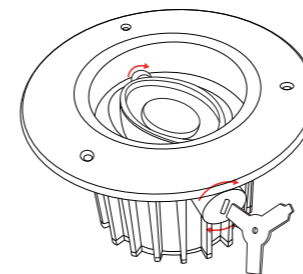

Adjust to the angle you want

## LED Adjustable Inground Light



### 2095R1\*α-A1-Y

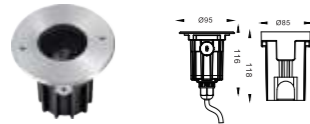

Power	LED	CCT	IK	Luminous	Input Voltage	Beam Angle
1x2W	OSRAM/CREE	Single	IK10	157lm	12/24 VDC/220-240VAC	5°/8°/15°/25°/40°/60°/10°/45°/20°/65°
1x3W	OSRAM	RGB 3in 1	IK10	60lm	12/24 VDC	12°/25°/40°/60°
1x4W	OSRAM	RGBW 4in 1	IK10	80lm	12/24 VDC	12°/25°/40°/60°



### 2180R1\*α-A1-Y-XX



Power	LED	CCT	IK	Luminous	Input Voltage	Beam Angle
6x3W	CREE	Single	IK10	1310lm	12/24 VDC/220-240VAC	3°/8°
9x2W	OSRAM/CREE	Single	IK10	1310lm	12/24 VDC/220-240VAC	15°/25°/40°/60°/10°/45°/20°/65°
6x2.5W	OSRAM	RGB 3in 1	IK10	425lm	12/24 VDC	12°/25°/40°/60°
6x3.5W	OSRAM	RGBW 4in 1	IK10	568lm	12/24 VDC	12°/25°/40°/60°



### 2130R1\*α-A1-Y-XX

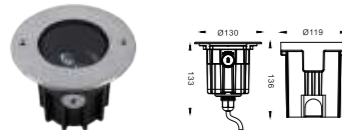

Power	LED	CCT	IK	Luminous	Input Voltage	Beam Angle
2x3W	CREE	Single	IK10	465lm	12/24 VDC/220-240VAC	3°/8°
3x2W	OSRAM/CREE	Single	IK10	465lm	12/24 VDC/220-240VAC	15°/25°/40°/60°/10°/45°/20°/65°
2x3W	OSRAM	RGB 3in 1	IK10	135lm	12/24 VDC	12°/25°/40°/60°
2x4W	OSRAM	RGBW 4in 1	IK10	182lm	12/24 VDC	12°/25°/40°/60°



### 2210R1\*α-A1-Y-XX

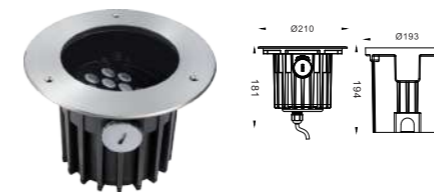

Power	LED	CCT	IK	Luminous	Input Voltage	Beam Angle
9x3W	CREE	Single	IK10	1800lm	12/24 VDC/220-240VAC	3°/8°
12x2W	OSRAM/CREE	Single	IK10	1850lm	12/24 VDC/220-240VAC	15°/25°/40°/60°/10°/45°/20°/65°
9x2.5W	OSRAM	RGB 3in 1	IK10	730lm	12/24 VDC	12°/25°/40°/60°
9x3.5W	OSRAM	RGBW 4in 1	IK10	978lm	12/24 VDC	12°/25°/40°/60°



### 2160R1\*α-A1-Y-XX



Power	LED	CCT	IK	Luminous	Input Voltage	Beam Angle
4x3W	CREE	Single	IK10	920lm	12/24 VDC/220-240VAC	3°/8°
6x2W	OSRAM/CREE	Single	IK10	920lm	12/24 VDC/220-240VAC	15°/25°/40°/60°/10°/45°/20°/65°
4x2.5W	OSRAM	RGB 3in 1	IK10	250lm	12/24 VDC	12°/25°/40°/60°
4x3.5W	OSRAM	RGBW 4in 1	IK10	430lm	12/24 VDC	12°/25°/40°/60°



### 2250R1\*α-A1-Y-XX

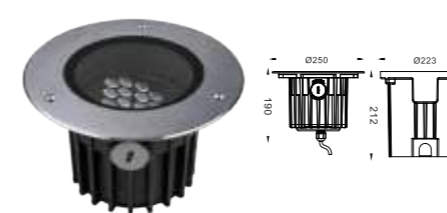

Power	LED	CCT	IK	Luminous	Input Voltage	Beam Angle
12x3W	CREE	Single	IK10	2800lm	12/24 VDC/220-240VAC	3°/8°
18x2W	OSRAM/CREE	Single	IK10	2800lm	12/24 VDC/220-240VAC	15°/25°/40°/60°/10°/45°/20°/65°
12x3W	OSRAM	RGB 3in 1	IK10	825lm	12/24 VDC	12°/25°/40°/60°
12x4W	OSRAM	RGBW 4in 1	IK10	1100lm	12/24 VDC	12°/25°/40°/60°





## LED Depth Illuminant Inground Light



### 2095R1\*α-A3-Y

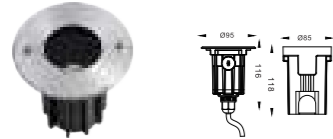

Power	LED	CCT	IK	Luminous	Input Voltage	Beam Angle
1x2W	OSRAM/CREE	Single	IK10	141lm	12/24 VDC/220-240VAC	5°/8°/15°/25°/40°/60°/10°45°/20°65°
1x3W	OSRAM	RGB 3in 1	IK10	60lm	12/24 VDC	12°/25°/40°/60°
1x4W	OSRAM	RGBW 4in 1	IK10	80lm	12/24 VDC	12°/25°/40°/60°



### 2210R1\*α-A3-Y

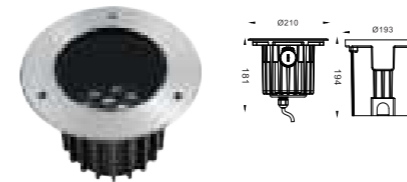

Power	LED	CCT	IK	Luminous	Input Voltage	Beam Angle
12x2W	OSRAM/CREE	Single	IK10	1424lm	12/24 VDC/220-240VAC	15°/25°/40°/60°/10°45°/20°65°
12x2.5W	OSRAM	RGB 3in 1	IK10	620lm	12/24 VDC	25°/40°/60°
12x3.5W	OSRAM	RGBW 4in 1	IK10	820lm	12/24 VDC	25°/40°/60°



### 2130R1\*α-A3-Y

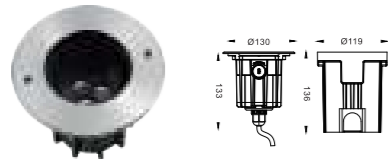

Power	LED	CCT	IK	Luminous	Input Voltage	Beam Angle
3x2W	OSRAM/CREE	Single	IK10	418lm	12/24 VDC/220-240VAC	15°/25°/40°/60°/10°45°/20°65°
3x3W	OSRAM	RGB 3in 1	IK10	128lm	12/24 VDC	25°/40°/60°
3x4W	OSRAM	RGBW 4in 1	IK10	228lm	12/24 VDC	25°/40°/60°

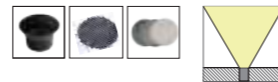

### 2250R1\*α-A3-Y



Power	LED	CCT	IK	Luminous	Input Voltage	Beam Angle
18x2W	OSRAM/CREE	Single	IK10	2240lm	12/24 VDC/220-240VAC	15°/25°/40°/60°/10°45°/20°65°
18x3W	OSRAM	RGB 3in 1	IK10	780lm	12/24 VDC	25°/40°/60°
18x4W	OSRAM	RGBW 4in 1	IK10	1170lm	12/24 VDC	25°/40°/60°



### 2160R1\*α-A3-Y

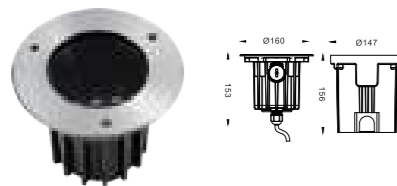

Power	LED	CCT	IK	Luminous	Input Voltage	Beam Angle
6x2W	OSRAM/CREE	Single	IK10	855lm	12/24 VDC/220-240VAC	15°/25°/40°/60°/10°45°/20°65°
6x2.5W	OSRAM	RGB 3in 1	IK10	250lm	12/24 VDC	25°/40°/60°
6x3.5W	OSRAM	RGBW 4in 1	IK10	430lm	12/24 VDC	25°/40°/60°

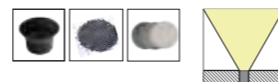

### 2180R1\*α-A3-Y

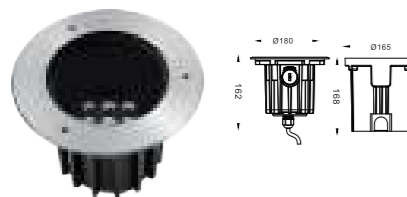

Power	LED	CCT	IK	Luminous	Input Voltage	Beam Angle
9x2W	OSRAM/CREE	Single	IK10	990lm	12/24 VDC/220-240VAC	15°/25°/40°/60°/10°45°/20°65°
9x2.5W	OSRAM	RGB 3in 1	IK10	380lm	12/24 VDC	25°/40°/60°
9x3.5W	OSRAM	RGBW 4in 1	IK10	410lm	12/24 VDC	25°/40°/60°

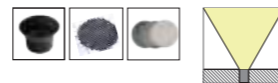

## LED Depth Illuminant Inground Light



### 2130R1\*α-B3-Y

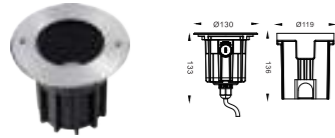

Power	LED	CCT	IK	Luminous	Input Voltage	Beam Angle
1x6W	CREE COB	Single	IK10	418lm	12/24 VDC/220-240VAC	18°/24°/38°/60°

### 2250R1\*α-B3-Y



Power	LED	CCT	IK	Luminous	Input Voltage	Beam Angle
1x36W	CREE COB	Single	IK10	2030lm	12/24 VDC/220-240VAC	18°/24°/38°/60°

### 2160R1\*α-B3-Y

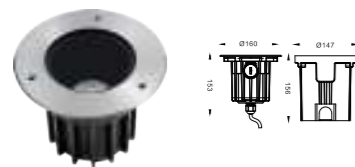

Power	LED	CCT	IK	Luminous	Input Voltage	Beam Angle
1x12W	CREE COB	Single	IK10	1120lm	12/24 VDC/220-240VAC	18°/24°/38°/60°

### 2180R1\*α-B3-Y

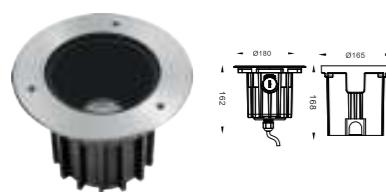

Power	LED	CCT	IK	Luminous	Input Voltage	Beam Angle
1x20W	CREE COB	Single	IK10	1245lm	12/24 VDC/220-240VAC	18°/24°/38°/60°

### 2210R1\*α-B3-Y

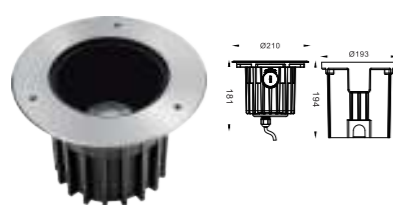

Power	LED	CCT	IK	Luminous	Input Voltage	Beam Angle
1x25W	CREE COB	Single	IK10	2030lm	12/24 VDC/220-240VAC	18°/24°/38°/60°



## LED COB Asymmetric Inground Light



### 2095R1\*α-B6-Y

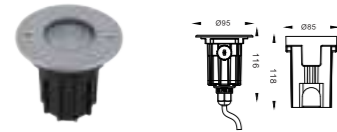

Power	LED	CCT	IK	Luminous	Input Voltage	Beam Angle
1x3W	CREE	Single	IK10	250lm	12/24 VDC/220-240VAC	Asymmetric

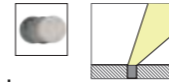

### 2210R1\*α-B6-Y

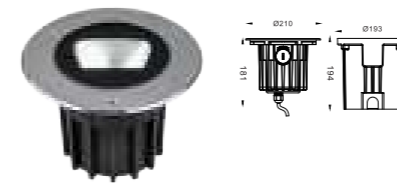

Power	LED	CCT	IK	Luminous	Input Voltage	Beam Angle
1x25W	CREE	Single	IK10	1900lm	12/24 VDC/220-240VAC	Asymmetric

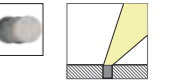

### 2130R1\*α-B6-Y

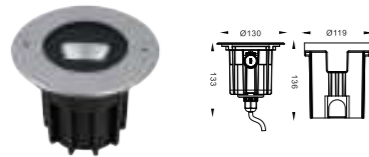

Power	LED	CCT	IK	Luminous	Input Voltage	Beam Angle
1x6W	CREE	Single	IK10	450lm	12/24 VDC/220-240VAC	Asymmetric

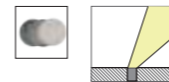

### 2250R1\*α-B6-Y



Power	LED	CCT	IK	Luminous	Input Voltage	Beam Angle
1x36W	CREE	Single	IK10	2600lm	12/24 VDC/220-240VAC	Asymmetric

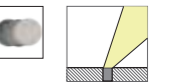

### 2160R1\*α-B6-Y

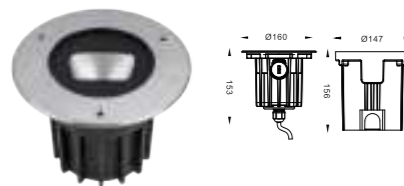

Power	LED	CCT	IK	Luminous	Input Voltage	Beam Angle
1x13W	CREE	Single	IK10	980lm	12/24 VDC/220-240VAC	Asymmetric



### 2180R1\*α-B6-Y

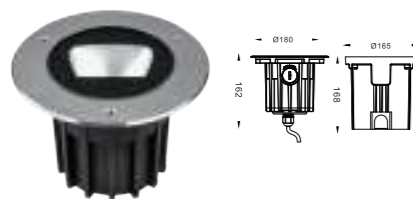

Power	LED	CCT	IK	Luminous	Input Voltage	Beam Angle
1x20W	CREE	Single	IK10	1100lm	12/24 VDC/220-240VAC	Asymmetric

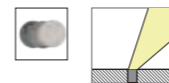

## LED COB Reflector Inground Light

CE ErP IP67 RoHS 1-10V Triac PWM DALI DALI2

### 2095R1\*α-B4-Y

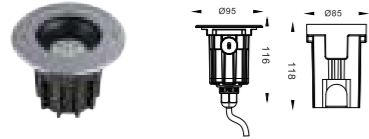

Power	LED	CCT	IK	Luminous	Input Voltage	Beam Angle
1x4W	CREE	Single	IK10	190lm	12/24 VDC/220-240VAC	20°/30°/40°

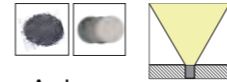

### 2210R1\*α-B4-Y

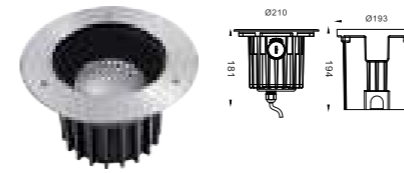

Power	LED	CCT	IK	Luminous	Input Voltage	Beam Angle
1x25W	CREE	Single	IK10	2030lm	12/24 VDC/220-240VAC	20°/30°/40°

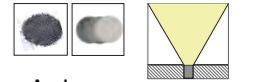

### 2130R1\*α-B4-Y

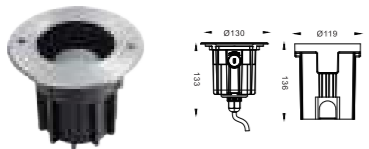

Power	LED	CCT	IK	Luminous	Input Voltage	Beam Angle
1x6W	CREE	Single	IK10	350lm	12/24 VDC/220-240VAC	20°/30°/40°

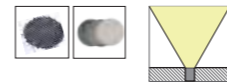

### 2250R1\*α-B4-Y



Power	LED	CCT	IK	Luminous	Input Voltage	Beam Angle
1x35W	CREE	Single	IK10	2780lm	12/24 VDC/220-240VAC	20°/30°/40°

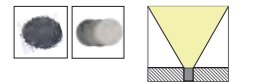

### 2160R1\*α-B4-Y

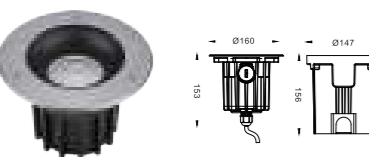

Power	LED	CCT	IK	Luminous	Input Voltage	Beam Angle
1x13W	CREE	Single	IK10	1120lm	12/24 VDC/220-240VAC	20°/30°/40°

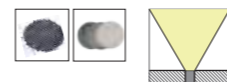

### 2180R1\*α-B4-Y

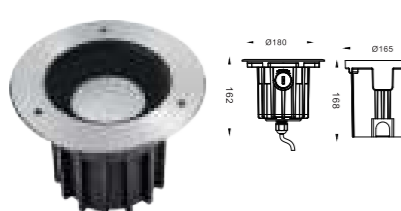

Power	LED	CCT	IK	Luminous	Input Voltage	Beam Angle
1x20W	CREE	Single	IK10	1250lm	12/24 VDC/220-240VAC	20°/30°/40°





## LED Inground Light



### 2010R1\*α-C7-X

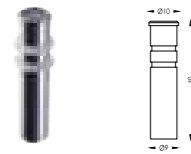

Power	LED	CCT	IK	Luminous	Input Voltage	Beam Angle
1x0.3W	OSRAM	Single	IK04	11lm	12 VDC	120°

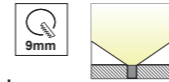

### 2038R1\*α-A3-Y

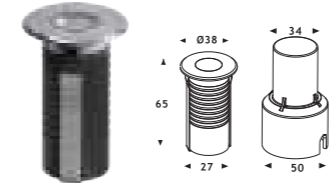

Power	LED	CCT	IK	Luminous	Input Voltage	Beam Angle
1x1.5W	CREE/OSRAM	Single	IK07	110lm	12/24 VDC	25°/40°/60°



### 2020R1\*α-C7-X

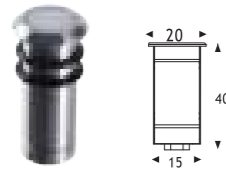

Power	LED	CCT	IK	Luminous	Input Voltage	Beam Angle
1x0.5W	OSRAM	Single	IK04	55lm	12 VDC	120°



### 2038S1\*α-A3-Y

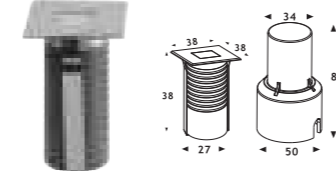

Power	LED	CCT	IK	Luminous	Input Voltage	Beam Angle
1x1.5W	CREE/OSRAM	Single	IK07	110lm	12/24 VDC	25°/40°/60°



### 2030R1\*α-C7-X

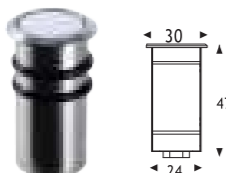

Power	LED	CCT	IK	Luminous	Input Voltage	Beam Angle
1x1W	OSRAM	Single	IK04	66lm	12/24 VDC	120°



### 2045R1\*α-A3-Y



Power	LED	CCT	IK	Luminous	Input Voltage	Beam Angle
1x2W	OSRAM/CREE	Single	IK08	130lm	12/24 VDC/220-240VAC	25°/40°/60°
1x3W	EPISTAR	RGB	IK08	130lm	12/24 VDC	25°/40°/60°



### 2030R2\*α-A3-X

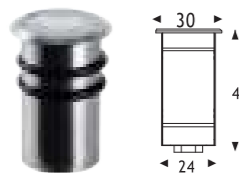

Power	LED	CCT	IK	Luminous	Input Voltage	Beam Angle
1x1W	OSRAM	Single	IK04	66lm	12/24 VDC	30°/60°

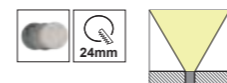

### 2045S1\*α-A3-Y

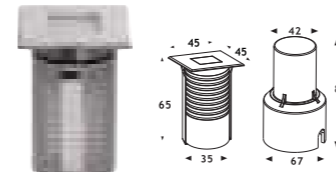

Power	LED	CCT	IK	Luminous	Input Voltage	Beam Angle
1x2W	OSRAM/CREE	Single	IK08	130lm	12/24 VDC/220-240VAC	120°
1x3W	OSRAM/CREE	RGB	IK08	130lm	12/24 VDC	120°



## LED COB Inground Light



### 2070R1\*α-B3-Y



Power	LED	CCT	IK	Luminous	Input Voltage	Beam Angle
1x4W	CREE COB	Single	IK09	398lm	12/24 VDC	15°/24°/36°/60°
1x5W	CREE COB	Single	IK09	508lm	12/24 VDC/220-240VAC	15°/24°/36°/60°
1x6W	OSRAM	RGB 3in 1	IK09	170lm	12/24 VDC	15°/25°/40°/60°
1x8W	OSRAM	RGBW 4in 1	IK09	225lm	12/24 VDC	15°/25°/40°/60°

### 2080R1\*b-B3-Y



Power	LED	CCT	IK	Luminous	Input Voltage	Beam Angle
1x9W	CREE COB	Single	IK09	904lm	12/24 VDC/220-240VAC	15°/24°/36°/60°
1x9W	OSRAM	RGB 3in 1	IK09	241lm	12/24 VDC	15°/25°/40°/60°
1x10W	OSRAM	RGBW 4in 1	IK09	281lm	12/24 VDC	15°/25°/40°/60°

### 2070S1\*α-B3-Y

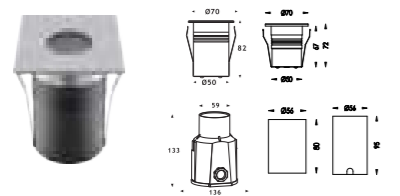

Power	LED	CCT	IK	Luminous	Input Voltage	Beam Angle
1x5W	CREE COB	Single	IK09	508lm	12/24 VDC/220-240VAC	15°/24°/36°/60°
1x6W	OSRAM	RGB 3in 1	IK09	170lm	12/24 VDC	15°/25°/40°/60°
1x8W	OSRAM	RGBW 4in 1	IK09	225lm	12/24 VDC	15°/25°/40°/60°

### 2080S1\*b-B3-Y



Power	LED	CCT	IK	Luminous	Input Voltage	Beam Angle
1x9W	CREE COB	Single	IK09	904lm	12/24 VDC/220-240VAC	15°/24°/36°/60°
1x9W	OSRAM	RGB 3in 1	IK09	241lm	12/24 VDC	15°/25°/40°/60°
1x10W	OSRAM	RGBW 4in 1	IK09	281lm	12/24 VDC	15°/25°/40°/60°

### 2116R2\*α-B3-Y

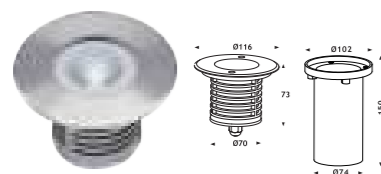

Power	LED	CCT	IK	Luminous	Input Voltage	Beam Angle
1x6W	CREE COB	Single	IK09	530lm	12/24 VDC/220-240VAC	15°/24°/38°/60°

### 2173R2\*α-B3-Y

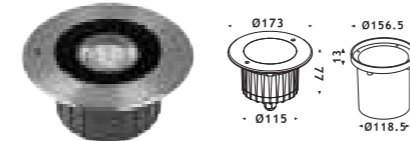

Power	LED	CCT	IK	Luminous	Input Voltage	Beam Angle
1x13W	CREE COB	Single	IK09	1492lm	12/24 VDC/220-240VAC	15°/24°/38°/60°

### 2116R2\*c-B3-Y

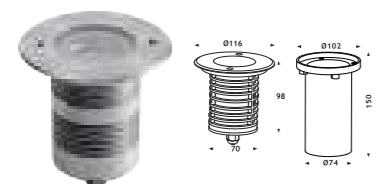

Power	LED	CCT	IK	Luminous	Input Voltage	Beam Angle
1x13W	CREE COB	Single	IK09	1352lm	12/24 VDC/220-240VAC	15°/24°/38°/60°

### 2186R2\*A-B3-Y

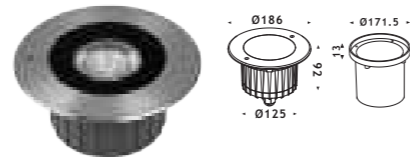

Power	LED	CCT	IK	Luminous	Input Voltage	Beam Angle
1x25W	CREE COB	Single	IK09	2520lm	12/24 VDC/220-240VAC	15°/24°/38°/60°

## LED Inground Light



### 2055R1\*α-A3-Y



Power	LED	CCT	IK	Luminous	Input Voltage	Beam Angle
1x2W	CREE/OSRAM	Single	IK08	120lm	12/24 VDC/220-240VAC	8°/12°/25°/40°/60°/10°45°/25°60°
1x3W	CREE/OSRAM	RGB 3in 1	IK08	50lm	12/24 VDC	12°/25°/40°/60°/10°45°/25°60°
1x4W	CREE/OSRAM	RGBW 4in 1	IK08	60lm	12/24 VDC	12°/25°/40°/60°/10°45°/25°60°

### 2173R2\*α-A3-Y

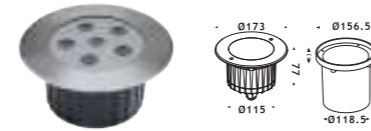

Power	LED	CCT	IK	Luminous	Input Voltage	Beam Angle
6x2W	CREE/OSRAM	Single	IK08	1080lm	12/24 VDC/220-240VAC	10°/25°/30°/45°/20   25°
6x2.5W	OSRAM	RGB 3in 1	IK08	620lm	12/24 VDC	12°/25°/30°/45°/20   25°

### 2055S1\*α-A3-Y

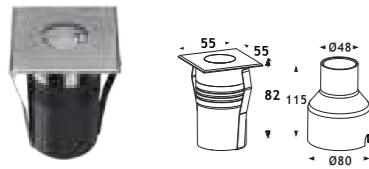

Power	LED	CCT	IK	Luminous	Input Voltage	Beam Angle
1x2W	CREE/OSRAM	Single	IK08	120lm	12/24 VDC/220-240VAC	8°/12°/25°/40°/60°/10°45°/25°60°
1x3W	CREE/OSRAM	RGB 3in 1	IK08	50lm	12/24 VDC	12°/25°/40°/60°/10°45°/25°60°
1x4W	CREE/OSRAM	RGBW 4in 1	IK08	60lm	12/24 VDC	12°/25°/40°/60°/10°45°/25°60°

### 2173S2\*α-A3-Y



Power	LED	CCT	IK	Luminous	Input Voltage	Beam Angle
6x2W	CREE/OSRAM	Single	IK08	1080lm	12/24 VDC/220-240VAC	10°/25°/30°/45°/20   25°
6x2.5W	OSRAM	RGB 3in 1	IK08	620lm	12/24 VDC	12°/25°/30°/45°/20   25°
9x1.5W	OSRAM	Single	IK08	1440lm	240V/120V	25°/40°/60°/80°/10°45°/25°45°
9x1.5W	OSRAM	RGB	IK08	1440lm	240V/120V	25°/40°/60°/80°/10°45°/25°45°
9x2.5W	OSRAM	RGB 3in 1	IK08	690lm	12/24 VDC	25°/40°/60°/80°/10°45°/25°45°

### 2116R2\*α-A3-Y

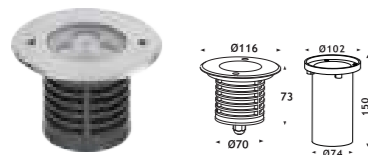

Power	LED	CCT	IK	Luminous	Input Voltage	Beam Angle
3x2W	CREE/OSRAM	Single	IK08	530lm	12/24 VDC/220-240VAC	5°/10°/25°/40°/60°/10°45°/25°60°
3x2.5W	OSRAM	RGB 3in 1	IK08	210lm	12/24 VDC	12°/25°/40°/60°/12°45°
3x3.5W	OSRAM	RGBW 4in 1	IK08	310lm	12/24 VDC	12°/25°/40°/60°/12°45°

### 21186R2\*α-A3-Y



Power	LED	CCT	IK	Luminous	Input Voltage	Beam Angle
12x2W	CREE/OSRAM	Single	IK08	530lm	12/24 VDC/220-240VAC	10°/25°/40°/60°/10°45°/25°45°
18x1.5W	CREE/OSRAM	RGB 3in 1	IK08	530lm	12/24 VDC/220-240VAC	12°/25°/40°/60°/10°45°/25°45°
12x2.5W	OSRAM	Single	IK08	210lm	240V/120V	12°/25°/40°/60°/12°45°
12x3.5W	OSRAM	RGB	IK08	1680lm	240V/120V	12°/25°/40°/60°/12°45°
18x1.5W	OSRAM	RGB	IK08	2100lm	12/24 VDC/220-240VAC	25°/40°/60°/80°/10°45°/25°45°
18x1.5W	OSRAM	RGB 3in 1	IK08	1500lm	12/24 VDC	25°/40°/60°/80°/10°45°/25°45°

### 2116S2\*α-A3-Y

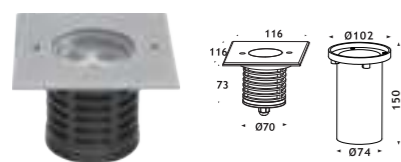

Power	LED	CCT	IK	Luminous	Input Voltage	Beam Angle
3x2W	CREE/OSRAM	Single	IK08	530lm	12/24 VDC/220-240VAC	5°/10°/25°/40°/60°/10°45°/25°60°
3x2.5W	OSRAM	RGB 3in 1	IK08	210lm	12/24 VDC	12°/25°/40°/60°/12°45°
3x3.5W	OSRAM	RGBW 4in 1	IK08	310lm	12/24 VDC	12°/25°/40°/60°/12°45°

### 2186S2\*α-A3-Y



Power	LED	CCT	IK	Luminous	Input Voltage	Beam Angle
12x2W	CREE/OSRAM	Single	IK08	530lm	12/24 VDC/220-240VAC	10°/25°/40°/60°/10°45°/25°60°
12x2.5W	OSRAM	RGB 3in 1	IK08	210lm	12/24 VDC	12°/25°/40°/60°/12°45°
12x3.5W	OSRAM	RGBW 4in 1	IK08	310lm	12/24 VDC	12°/25°/40°/60°/12°45°

## LED Inground Light



### 2055R7\*b-A3-Y



Power	LED	CCT	IK	Luminous	Input Voltage	Beam Angle
1x2W	CREE/OSRAM	Single	IK08	20lm	12/24 VDC/220-240VAC	360°
1x3W	CREE/OSRAM	RGB 3in 1	IK08	20lm	12/24 VDC	360°
1x4W	CREE/OSRAM	RGBW 4in 1	IK08	20lm	12/24 VDC	360°



### 2097R6\*d-xx-Y

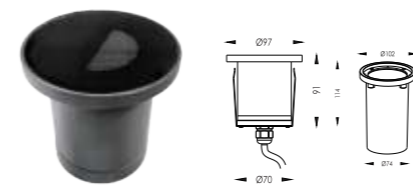

Power	LED	CCT	IK	Luminous	Input Voltage	Beam Angle
1x6W	CREE COB	Single	IK08	510lm	12/24 VDC/220-240VAC	15°/24°/36°/60°/120°
3x2W	OSRAM/CREE	Single	IK08	390lm	12/24 VDC/220-240VAC	15°/20°/25°/40°/60°

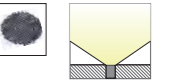

### 2055R5\*α-A3-Y



Power	LED	CCT	IK	Luminous	Input Voltage	Beam Angle
1x2W	CREE/OSRAM	Single	IK08	120lm	12/24 VDC/220-240VAC	8°/12°/25°/40°/60°/10°/45°/25°/45°
1x3W	CREE/OSRAM	RGB 3in 1	IK08	50lm	12/24 VDC	12°/25°/40°/60°/10°/45°/25°/45°
1x4W	CREE/OSRAM	RGBW 4in 1	IK08	60lm	12/24 VDC	12°/25°/40°/60°/10°/45°/25°/45°



### 2097R4\*d-xx-Y



Power	LED	CCT	IK	Luminous	Input Voltage	Beam Angle
1x6W	CREE COB	Single	IK08	510lm	12/24 VDC/220-240VAC	15°/24°/36°/60°/120°
3x2W	OSRAM/CREE	Single	IK08	290lm	12/24 VDC/220-240VAC	15°/20°/25°/40°/60°



### 2070R5\*α-A3-Y



Power	LED	CCT	IK	Luminous	Input Voltage	Beam Angle
1x5W	CREE/OSRAM	Single	IK08	360lm	12/24 VDC/220-240VAC	8°/12°/25°/40°/60°/10°/45°/25°/45°
1x5W	CREE/OSRAM	RGB 3in 1	IK08	120lm	12/24 VDC	12°/25°/40°/60°/10°/45°/25°/45°
1x6W	CREE/OSRAM	RGBW 4in 1	IK08	170lm	12/24 VDC	12°/25°/40°/60°/10°/45°/25°/45°



## Slim Type LED Inground Light

CE ERP IP67 RoHS 1-10V Triac PWM DALI RGBW

### 2050R1\* $\alpha$ -A3-Y

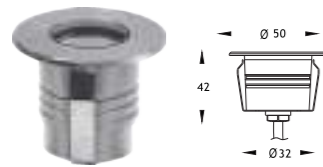

Power	LED	CCT	IK	Luminous	Input Voltage	Beam Angle
1x1.5W	CREE/OSRAM	Single	IK08	80lm	12/24 VDC	10°/25°/45°/60°



### 2116R2\* $b$ -A3-Y



Power	LED	CCT	IK	Luminous	Input Voltage	Beam Angle
3x2W	CREE/OSRAM	Single	IK09	520lm	12/24 VDC/220-240VAC	5°/10°/25°/40°/60°
3x2.5W	OSRAM	RGB 3in 1	IK09	210lm	12/24 VDC	10°/25°/40°/60°



### 2050S1\* $\alpha$ -A3-Y

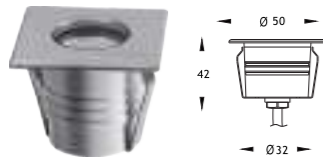

Power	LED	CCT	IK	Luminous	Input Voltage	Beam Angle
1x1.5W	CREE/OSRAM	Single	IK08	80lm	12/24 VDC	10°/25°/45°/60°



### 2116S2\* $b$ -A3-Y

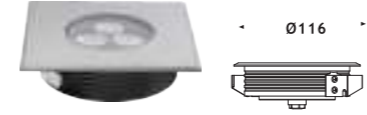

Power	LED	CCT	IK	Luminous	Input Voltage	Beam Angle
3x2W	CREE/OSRAM	Single	IK09	520lm	12/24 VDC/220-240VAC	10°/25°/40°/60°
3x2.5W	OSRAM	RGB 3in 1	IK09	210lm	12/24 VDC	12°/25°/40°/60°



### 2058R1\* $\alpha$ -A3-Y

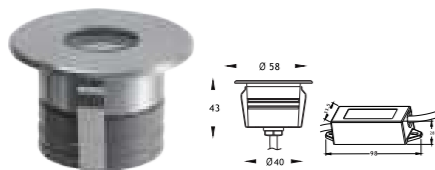

Power	LED	CCT	IK	Luminous	Input Voltage	Beam Angle
1x1.5W	CREE/OSRAM	Single	IK09	110lm	12/24 VDC/220-240VAC	10°/25°/45°/60°
1x2W	OSRAM	RGB 3in 1	IK09	70lm	12/24 VDC	10°/25°/45°/60°



### 2173R2\* $b$ -A3-Y



Power	LED	CCT	IK	Luminous	Input Voltage	Beam Angle
6x2W	OSRAM/CREE	Single	IK09	420lm	12/24 VDC/220-240VAC	10°/25°/40°/60°
6x2.5W	OSRAM	RGB 3in 1	IK09	450lm	12/24 VDC	12°/25°/40°/60°
6x3.5W	OSRAM	RGBW 4in 1	IK09	630lm	12/24 VDC	12°/25°/40°/60°



### 2058S1\* $\alpha$ -A3-Y

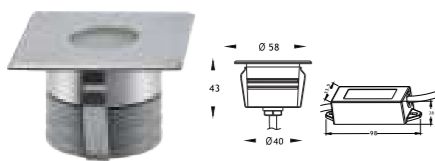

Power	LED	CCT	IK	Luminous	Input Voltage	Beam Angle
1x1.5W	CREE/OSRAM	Single	IK09	110lm	12/24 VDC/220-240VAC	10°/25°/45°/60°
1x2W	OSRAM	RGB 3in 1	IK09	70lm	12/24 VDC	12°/25°/45°/60°



### 2173S2\* $b$ -A3-Y

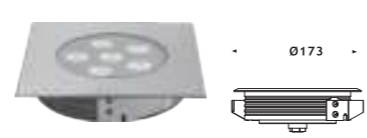

Power	LED	CCT	IK	Luminous	Input Voltage	Beam Angle
6x2W	OSRAM/CREE	Single	IK09	420lm	12/24 VDC/220-240VAC	10°/25°/40°/60°
6x2.5W	OSRAM	RGB 3in 1	IK09	450lm	12/24 VDC	12°/25°/40°/60°
6x3.5W	OSRAM	RGBW 4in 1	IK09	630lm	12/24 VDC	12°/25°/40°/60°



## LED Inground Side Light

CE ErP IP67 RoHS 1-10V Triac PWM DALI RGB RGBW

### 2055R7\* $\alpha$ -A3-Y-1 WAY/2 WAY/4 WAY

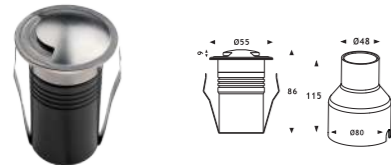

Power	LED	CCT	IK	Luminous	Input Voltage	Beam Angle
1x2W	CREE/OSRAM	Single	IK09	15lm	12/24 VDC/220-240VAC	1 WAY/2 WAY/4 WAY
1x2W	OSRAM	RGB 3in 1	IK09	10lm	12/24 VDC	1 WAY/2 WAY/4 WAY



### 2116R7\*b-C7-Y-1 WAY/2 WAY/4 WAY

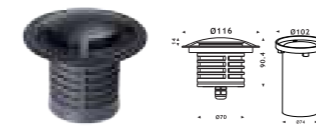

Power	LED	CCT	IK	Luminous	Input Voltage	Beam Angle
3-6W	OSRAM	Single	IK09	--	12/24 VDC/220-240VAC	1 WAY/2 WAY
3-6W	OSRAM	RGB 3in 1	IK09	--	12/24 VDC	1 WAY/2 WAY
2x2W	OSRAM	Single	IK09	--	12/24 VDC/220-240VAC	20°/40°/60°



### 2070R7\* $\alpha$ -A3-Y-1 WAY/2 WAY/4 WAY



Power	LED	CCT	IK	Luminous	Input Voltage	Beam Angle
1x2W	CREE/OSRAM	Single	IK10	15lm	12/24 VDC/220-240VAC	1 WAY/2 WAY/4 WAY
1x2W	OSRAM	RGB 3in 1	IK10	10lm	12/24 VDC	1 WAY/2 WAY/4 WAY



### 2116R7\*b-C7-X-1 WAY/2 WAY/4 WAY

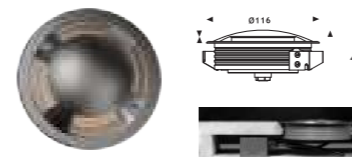

Power	LED	CCT	IK	Luminous	Input Voltage	Beam Angle
6W	OSRAM	Single	IK09	50lm	12/24 VDC/220-240VAC	1 WAY/2 WAY/4 WAY
6W	OSRAM	RGB 3in 1	IK09	30lm	12/24 VDC	1 WAY/2 WAY/4 WAY

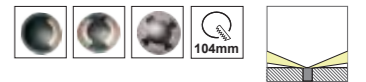

### 2116R7\* $\alpha$ -C7-Y-1 WAY/2 WAY/4 WAY



Power	LED	CCT	IK	Luminous	Input Voltage	Beam Angle
3-6W	OSRAM	Single	IK10	--	12/24 VDC/220-240VAC	1 WAY/2 WAY/4 WAY
3-6W	OSRAM	RGB 3in 1	IK10	--	12/24 VDC	1 WAY/2 WAY/4 WAY
2x2W	OSRAM	Single	IK10	--	12/24 VDC/220-240VAC	20°/40°/60°



### 2173R7\*b-C7-X-1 WAY/2 WAY/4 WAY

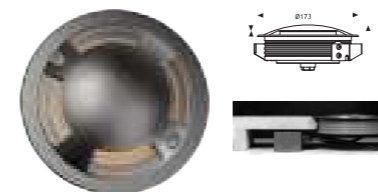

Power	LED	CCT	IK	Luminous	Input Voltage	Beam Angle
12W	OSRAM	Single	IK09	100lm	12/24 VDC/220-240VAC	1 WAY/2 WAY/4 WAY
12W	OSRAM	RGB 3in 1	IK09	70lm	12/24 VDC	1 WAY/2 WAY/4 WAY

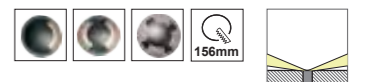

### 2173R7\* $\alpha$ -C7-Y-1 WAY/2 WAY/4 WAY



Power	LED	CCT	IK	Luminous	Input Voltage	Beam Angle
6-12W	OSRAM	Single	IK10	--	12/24 VDC/220-240VAC	1 WAY/2 WAY/4 WAY
6-12W	OSRAM	RGB 3in 1	IK10	--	12/24 VDC	1 WAY/2 WAY/4 WAY
2x3W	OSRAM	Single	IK10	--	12/24 VDC/220-240VAC	20°/40°/60°



## LED Linear Inground Light

Range of linear In-Ground walk over luminaires are developed for elegant grazing light effect. These luminaires perfectly suits for building facades, pathways & wall grazing.

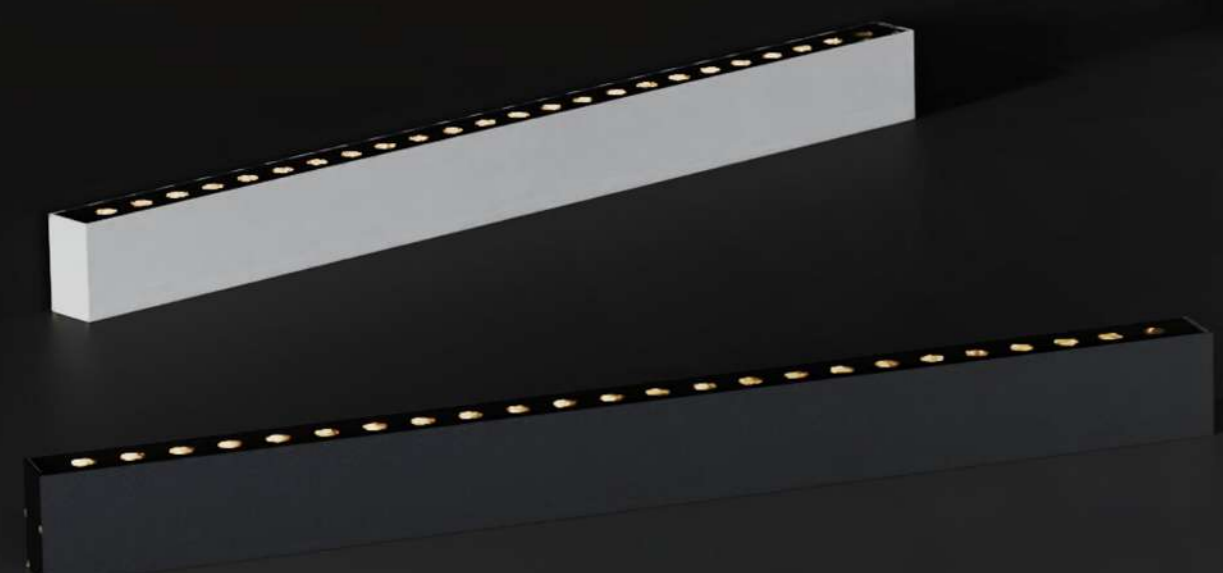



Uplights

	Symmetrical Lens	
		8°, 10°, 15°
		25°, 40°, 60°

Wallwasher Light

		Asymmetrical Lens
		10° 60°, 20° 40° 20° 45°, 20° 60°

Wallwasher Light

			Asymmetrical Lens 45° 35°



LED Linear Inground Light

Website: [WWW.iliteuk.com](http://WWW.iliteuk.com)

Email: [sales@iliteuk.com](mailto:sales@iliteuk.com)

Address: 1 Hatton Street, London, United Kingdom, NW8 8PL



**LED Linear Inground Light**

Minimalist design and shallow recessing depth allow for discrete installation in narrow places.

Available in three sizes and different color temperatures.

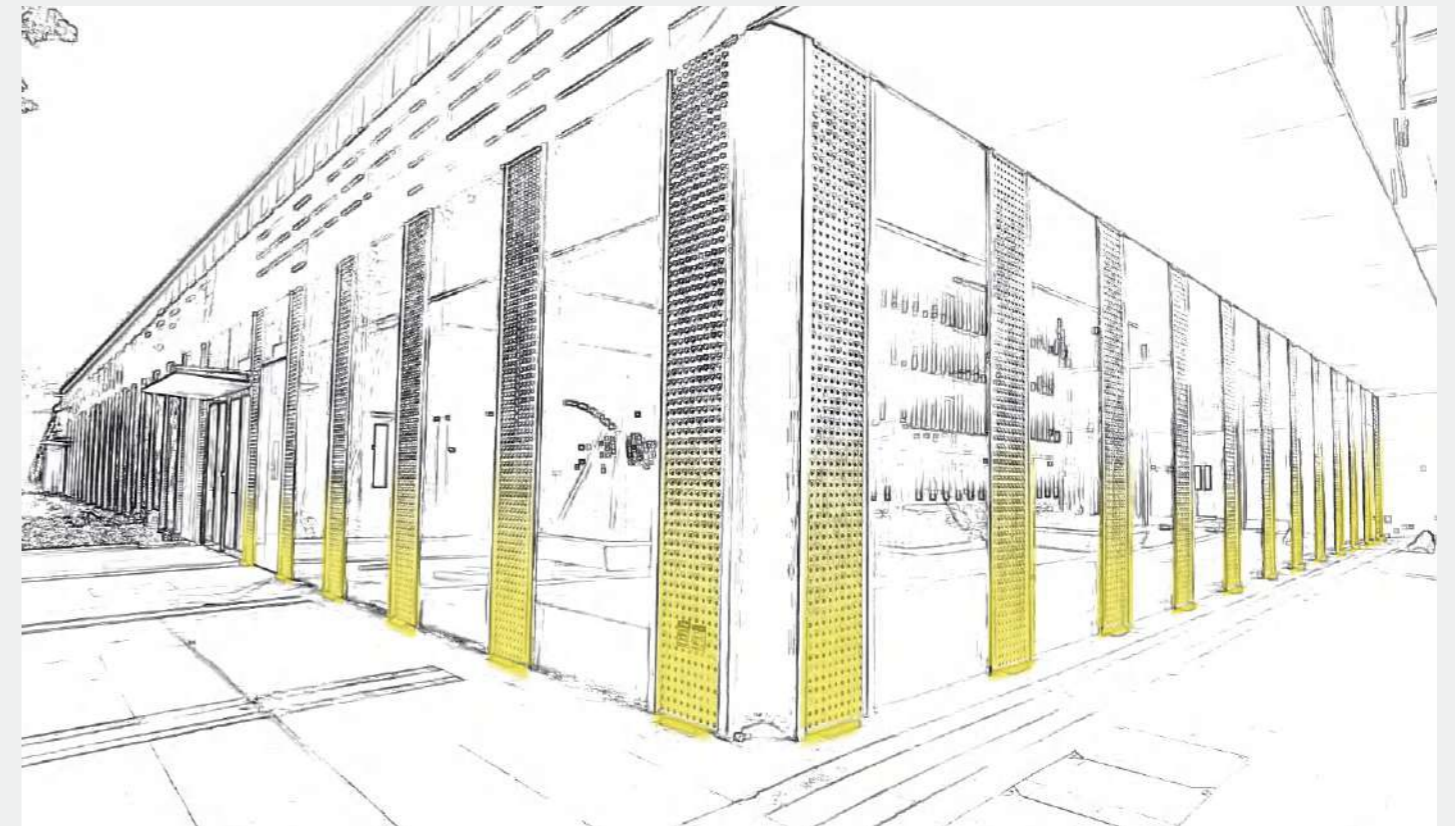

**Material Quality**

12# Die-casting powder coated aluminum housing  
Titanium chrome white SUS 316L front cover  
Tempered glass.

Luminaire housing and recessed housing made of aluminium, Front-cover 316L stainless steel, safety glass, white or clear.

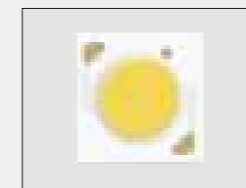

**LED**

CREE/OSRAM/BRIDGELUX, CRI>80(CRI>90 on request)  
Cable 0.5m  
ABS Mounting sleeve



**Quality/Supporting**

IP67 IK10  
Life time ≥50000 hrs  
Operating temperature -20 C -40 C

## LED Linear Inground Light

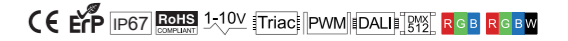

### 2064L2#a-A3-Y-0.302M



Power	LED	CCT	IK	Luminous	Input Voltage	Beam Angle
6x2W	OSRAM	Single	IK08	960lm	12/24 VDC/220-240VAC	8°/12°/25°/40°/60°
6x2.5W	OSRAM	RGB 3in 1	IK08	435lm	12/24 VDC	12°/25°/40°/60°
6x3.5W	OSRAM	RGBW 4in 1	IK08	600lm	12/24 VDC	12°/25°/40°/60°

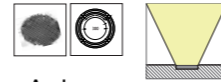

### 2063L4#a-C7-Y-0.195M

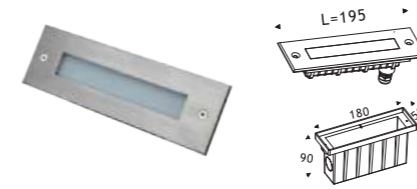

Power	LED	CCT	IK	Luminous	Input Voltage	Beam Angle
2.2W	OSRAM	Single	IK08	25lm	12/24 VDC/220-240VAC	120°
2.2W	OSRAM	RGB 3in 1	IK08	25lm	12/24 VDC	120°

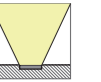

### 2064L2#a-A3-Y-0.369M

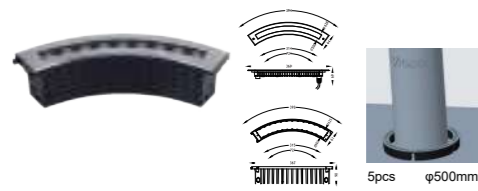

Power	LED	CCT	IK	Luminous	Input Voltage	Beam Angle
9x2W	OSRAM	Single	IK08	1380lm	12/24 VDC/220-240VAC	8°/12°/25°/40°/60°
9x2.5W	OSRAM	RGB 3in 1	IK08	660lm	12/24 VDC	12°/25°/40°/60°
9x3.5W	OSRAM	RGBW 4in 1	IK08	928lm	12/24 VDC	12°/25°/40°/60°

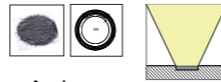

### 2063L4#a-C7-Y-0.328M



Power	LED	CCT	IK	Luminous	Input Voltage	Beam Angle
3-6W	OSRAM	Single	IK08	--	12/24 VDC/220-240VAC	120°
3-6W	OSRAM	RGB 3in 1	IK08	--	12/24 VDC	120°

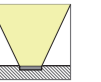

### 2063L2#a-A3-Y-0.195M

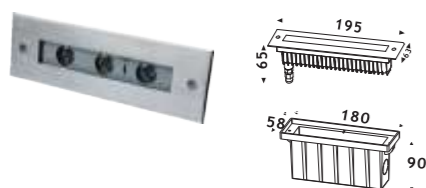

Power	LED	CCT	IK	Luminous	Input Voltage	Beam Angle
3x2W	OSRAM	Single	IK08	530lm	12/24 VDC/220-240VAC	8°/12°/25°/40°/60°
3x2.5W	OSRAM	RGB 3in 1	IK08	210lm	12/24 VDC	12°/25°/40°/60°
3x3.5W	OSRAM	RGBW 4in 1	IK08	310lm	12/24 VDC	12°/25°/40°/60°

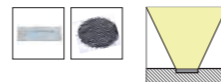

### 2063L2#a-A3-Y-0.328M



Power	LED	CCT	IK	Luminous	Input Voltage	Beam Angle
6x2W	OSRAM	Single	IK08	960lm	12/24 VDC/220-240VAC	12°/25°/40°/60°
6x2.5W	OSRAM	RGB 3in 1	IK08	435lm	12/24 VDC	12°/25°/40°/60°
6x3.5W	OSRAM	RGBW 4in 1	IK08	600lm	12/24 VDC	12°/25°/40°/60°

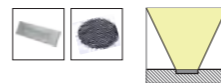

## LED Linear Inground Light



### 2055L2#α-A3-Y-0.275M/0.5M/1M

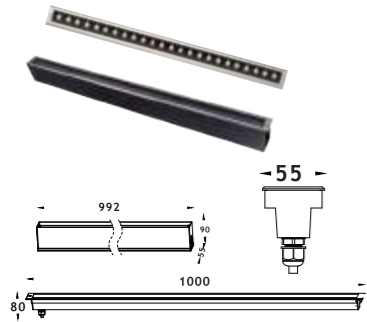
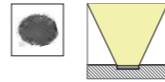

Power	LED	CCT	IK	Luminous	Input Voltage	Beam Angle
6x2W(0.275M)	OSRAM	Single	IK10	700lm	12/24 VDC/220-240VAC	15°/20°/30°/45°/60°/10°*30°/10°*45°/15°*45°/10°*60°
12x2W(0.5M)	OSRAM	Single	IK10	1390lm	12/24 VDC/220-240VAC	15°/20°/30°/45°/60°/10°*30°/10°*45°/15°*45°/10°*60°
24x2W(1M)	OSRAM	Single	IK10	2780lm	12/24 VDC/220-240VAC	15°/20°/30°/45°/60°/10°*30°/10°*45°/15°*45°/10°*60°
24x2.5W(1M)	OSRAM	RGB 3in 1	IK10	2780lm	12/24 VDC	15°/20°/30°/45°/60°/10°*30°/10°*45°/15°*45°/10°*60°
24x3.5W(1M)	OSRAM	RGBW 4in 1	IK10	2780lm	12/24 VDC	15°/20°/30°/45°/60°/10°*30°/10°*45°/15°*45°/10°*60°

### 2070L2#α-A3-Y-0.3M/0.5M/1M

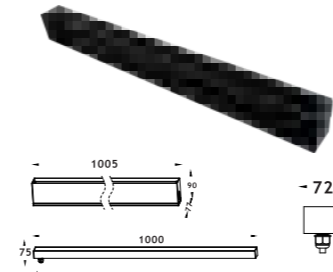
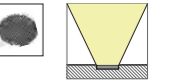

Power	LED	CCT	IK	Luminous	Input Voltage	Beam Angle
12x1.5W(0.3M)	OSRAM	Single	IK10	700lm	12/24 VDC/220-240VAC	10°/20°/30°/45°/60°
24x1.5W(0.5M)	OSRAM	Single	IK10	1390lm	12/24 VDC/220-240VAC	10°/20°/30°/45°/60°
48x1.5W(1M)	OSRAM	Single	IK10	2780lm	12/24 VDC/220-240VAC	10°/20°/30°/45°/60°
48x2W(1M)	OSRAM	RGB 3in 1	IK10	2780lm	12/24 VDC	10°/20°/30°/45°/60°
48x3W(1M)	OSRAM	RGBW 4in 1	IK10	2780lm	12/24 VDC	10°/20°/30°/45°/60°

### 2090L2#α-A3-Y-0.3M/0.5M/1M

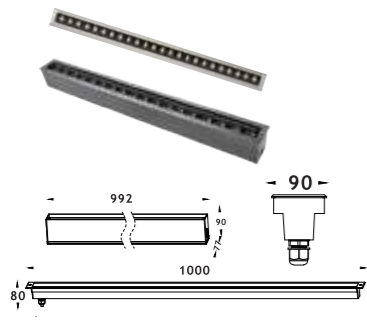
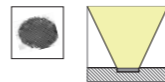

Power	LED	CCT	IK	Luminous	Input Voltage	Beam Angle
6x2W(0.3M)	OSRAM	Single	IK10	700lm	12/24 VDC/220-240VAC	15°/20°/30°/45°/60°/10°*30°/10°*45°/15°*45°/10°*60°
12x2W(0.5M)	OSRAM	Single	IK10	1390lm	12/24 VDC/220-240VAC	15°/20°/30°/45°/60°/10°*30°/10°*45°/15°*45°/10°*60°
24x2W(1M)	OSRAM	Single	IK10	2780lm	12/24 VDC/220-240VAC	15°/20°/30°/45°/60°/10°*30°/10°*45°/15°*45°/10°*60°
24x2.5W(1M)	OSRAM	RGB 3in 1	IK10	2780lm	12/24 VDC	15°/20°/30°/45°/60°/10°*30°/10°*45°/15°*45°/10°*60°
24x3.5W(1M)	OSRAM	RGBW 4in 1	IK10	2780lm	12/24 VDC	15°/20°/30°/45°/60°/10°*30°/10°*45°/15°*45°/10°*60°

### 2050L4#α-C7-Y-0.275M/0.5M/1M

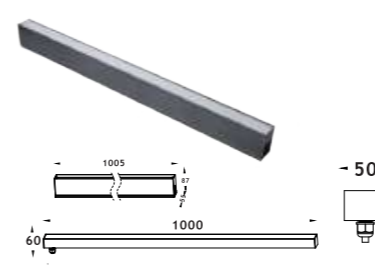

Power	LED	CCT	IK	Luminous	Input Voltage	Beam Angle
9W(0.275M)	OSRAM	Single	IK10	2780lm	12/24 VDC/220-240VAC	120°
18W(0.5M)	OSRAM	Single	IK10	2780lm	12/24 VDC/220-240VAC	120°
35W(1M)	OSRAM	Single	IK10	2780lm	12/24 VDC/220-240VAC	120°

### 2032L2#α-A3-Y-0.275M/0.5M/1M

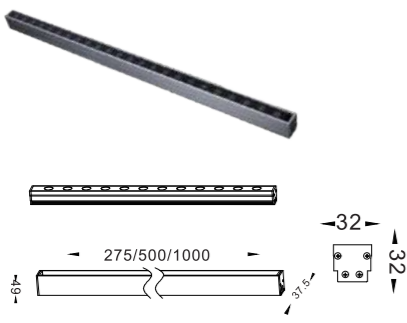
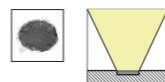

Power	LED	CCT	IK	Luminous	Input Voltage	Beam Angle
6x1.5W(0.275M)	OSRAM	Single	IK08	610lm	12/24 VDC	15°/20°/30°/45°/60°/10°*30°/10°*45°/15°*45°/10°*60°
12x1.5W(0.5M)	OSRAM	Single	IK08	1220lm	12/24 VDC	15°/20°/30°/45°/60°/10°*30°/10°*45°/15°*45°/10°*60°
24x1.5W(1M)	OSRAM	Single	IK08	2450lm	12/24 VDC	15°/20°/30°/45°/60°/10°*30°/10°*45°/15°*45°/10°*60°

### 2020L4#α-C7-Y



Power	LED	CCT	IK	Luminous	Input Voltage	Beam Angle
3W(0.3M)	SMD	Single	IK10	222lm	24 VDC	120°
5W(0.5M)	SMD	Single	IK10	542lm	24 VDC	120°
10W(1M)	SMD	Single	IK10	1084lm	24 VDC	120°

### 2050L2#α-A3-Y-0.275M/0.5M/1M

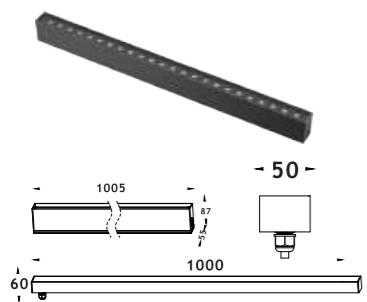
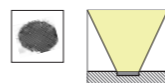

Power	LED	CCT	IK	Luminous	Input Voltage	Beam Angle
6x2W(0.275M)	OSRAM	Single	IK10	700lm	12/24 VDC/220-240VAC	15°/20°/30°/45°/60°/10°*30°/10°*45°/15°*45°/10°*60°
12x2W(0.5M)	OSRAM	Single	IK10	1390lm	12/24 VDC/220-240VAC	15°/20°/30°/45°/60°/10°*30°/10°*45°/15°*45°/10°*60°
24x2W(1M)	OSRAM	Single	IK10	2780lm	12/24 VDC/220-240VAC	15°/20°/30°/45°/60°/10°*30°/10°*45°/15°*45°/10°*60°
24x2.5W(1M)	OSRAM	RGB 3in 1	IK10	2780lm	12/24 VDC	15°/20°/30°/45°/60°/10°*30°/10°*45°/15°*45°/10°*60°
24x3.5W(1M)	OSRAM	RGBW 4in 1	IK10	2780lm	12/24 VDC	15°/20°/30°/45°/60°/10°*30°/10°*45°/15°*45°/10°*60°

### 2030L4#α-C7-Y



Power	LED	CCT	IK	Luminous	Input Voltage	Beam Angle
6W(0.3M)	SMD	Single	IK10	325lm	12/24 VDC	120°
10W(0.5M)	SMD	Single	IK10	542lm	12/24 VDC	120°
20W(1M)	SMD	Single	IK10	1084lm	12/24 VDC	120°

## LED Spot Light

Spot luminaires stands out for special housing design and high quality optical components specifically for demanding visual tasks to provide enhanced visual comfort.

Housing made of 12# Die-casting aluminum with Akzo power coated Clear tempered safety glass, transmittance of light is over 95% and the accuracy of color temperature as well as strong impact resistance bearing capacity. Quick & simple installation with low maintenance.





Uplights



Floodlight



Lens Wallwashers



## LED Spot Light

WB Spot light series with exemplary design and compact dimensions. With precise optics they are used for accent lighting on façades or to illuminate objects from a long distance.

The spot light are available in 4 different sizes and wattages. There is a choice of different optics – collimators, wide beam reflectors or an optic for uniform illumination of streets and pathways.



**Workmanship:**

Akzo powder coat finish as standard: White, Black, Grey;

**Customized:**

Silver, Golden, Bronze, etc.

**Variable Focusing Beam Angle Available  
From 15° to 60°**

Zoomable focus lighting fixtures are equipped with adjustable focusing lenses or zoom systems, enabling users to change the focus of the beam. By rotating or adjusting specific parts of the fixture, a smooth transition can be achieved from a focused beam to a wider floodlight, catering to diverse lighting requirements.

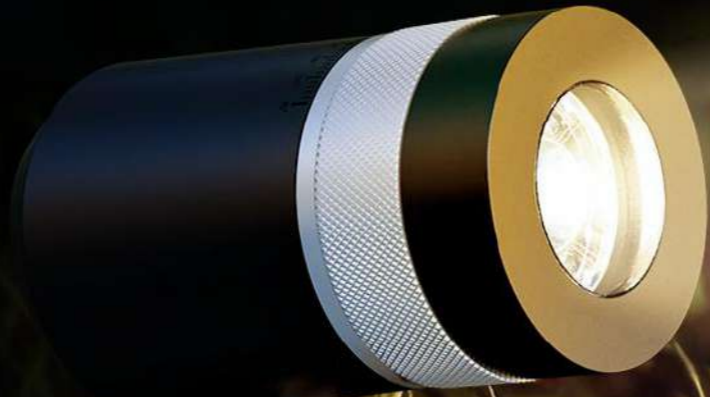



**WB Spot light series**

Sturdy construction in order to maintain performance of the luminaire and to reduce maintenance costs.

Applicable for outdoor installation, hotel, villa, facade, garden, residential.



**Material Quality**

12# Die-casting powder coated aluminum housing  
Tempered glass

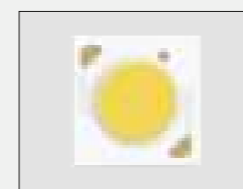

**LED**

CREE/OSRAM/BRIDGELUX, CRI>80(CRI>90 on request)  
Cable 0.5m



**Quality/Supporting**

P66 IK08  
Life time ≥50000 hrs  
Operating temperature -20°C~40°C  
Spike/Base plate/Pole/Hood/Tree strap

Comes with arich range of useful accessories both to solve different types of installation and to control glare.

## Zoomable LED Landscape Spot Light

CE ErP IP66 RoHS 1-10V Triac PWM DALI RGB RGBW

### 3060R1\*b-B3-M

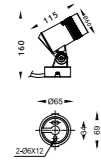

Power	LED	CCT	IK	Luminous	Input Voltage	Beam Angle
1x6W	CREE COB	Single	IK05	380lm	12/24 VDC/220-240VAC	15-60°

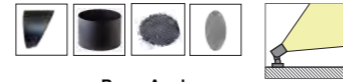

### 3060R1\*b-B3-B

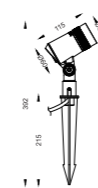

Power	LED	CCT	IK	Luminous	Input Voltage	Beam Angle
1x6W	CREE COB	Single	IK05	380lm	12/24 VDC/220-240VAC	15-60°

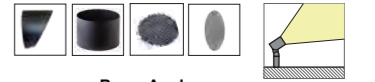

### 3080R1\*b-B3-M

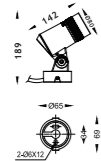

Power	LED	CCT	IK	Luminous	Input Voltage	Beam Angle
1x12W	CREE COB	Single	IK05	940lm	12/24 VDC/220-240VAC	15-60°

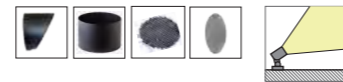

### 3080R1\*b-B3-B

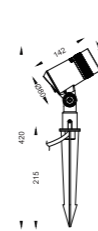

Power	LED	CCT	IK	Luminous	Input Voltage	Beam Angle
1x12W	CREE COB	Single	IK05	940lm	12/24 VDC/220-240VAC	15-60°

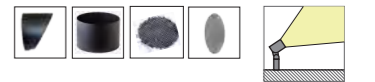

### 3100R1\*b-B3-M

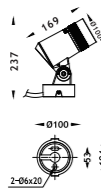

Power	LED	CCT	IK	Luminous	Input Voltage	Beam Angle
1x20W	CREE COB	Single	IK05	1420lm	12/24 VDC/220-240VAC	15-60°

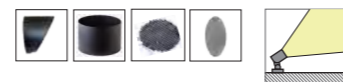

### 3100R1\*b-B3-B

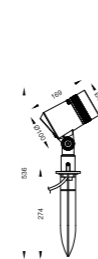

Power	LED	CCT	IK	Luminous	Input Voltage	Beam Angle
1x20W	CREE COB	Single	IK05	1420lm	12/24 VDC/220-240VAC	15-60°

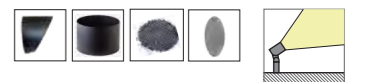

### 3150R1\*b-B3-M

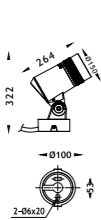

Power	LED	CCT	IK	Luminous	Input Voltage	Beam Angle
1x40W	CREE COB	Single	IK05	2500lm	12/24 VDC/220-240VAC	15-60°

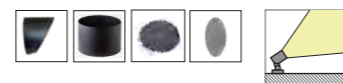

### 3150R1\*b-B3-B

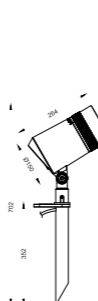

Power	LED	CCT	IK	Luminous	Input Voltage	Beam Angle
1x40W	CREE COB	Single	IK05	2500lm	12/24 VDC/220-240VAC	15-60°

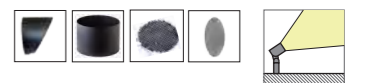

## Zoomable LED Landscape Spot Light

CE ErP IP66 RoHS 1-10V Triac PWM DALI RGBW

### 3060R1\*b-B3-H

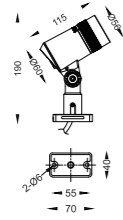

Power	LED	CCT	IK	Luminous	Input Voltage	Beam Angle
1x6W	CREE COB	Single	IK05	380lm	12/24 VDC/220-240VAC	15-60°



### 3080R1\*b-B3-H

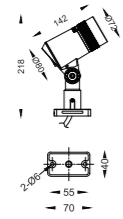

Power	LED	CCT	IK	Luminous	Input Voltage	Beam Angle
1x12W	CREE COB	Single	IK05	940lm	24 VDC/220-240VAC	15-60°

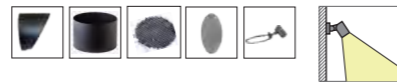

### 3100R1\*b-B3-H

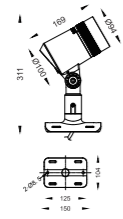

Power	LED	CCT	IK	Luminous	Input Voltage	Beam Angle
1x20W	CREE	Single	IK05	1420lm	24 VDC/220-240VAC	15-60°

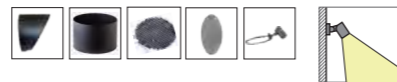

### 3150R1\*b-B3-H

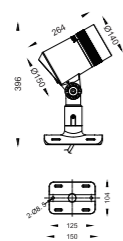

Power	LED	CCT	IK	Luminous	Input Voltage	Beam Angle
1x40W	CREE	Single	IK05	2500lm	24 VDC/220-240VAC	15-60°

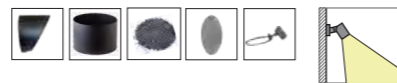

## Zoomable LED Landscape Spot Light

CE ErP IP66 RoHS 1-10V Triac PWM DALI RGBW

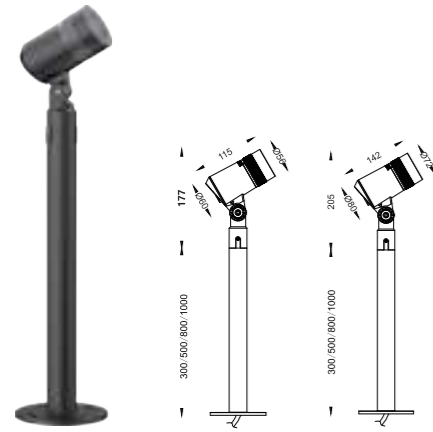

### 3060R1\*b-B3-M2

Power	LED	CCT	IK	Luminous	Input Voltage	Beam Angle
1x6W	CREE COB	Single	IK05	380lm	12/24 VDC/220-240VAC	15-60°

### 3080R1\*b-B3-M2

Power	LED	CCT	IK	Luminous	Input Voltage	Beam Angle
1x12W	CREE COB	Single	IK05	940lm	24 VDC/220-240VAC	15-60°

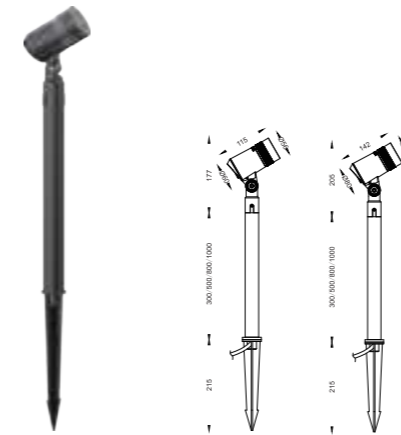

### 3060R1\*b-B3-B2

Power	LED	CCT	IK	Luminous	Input Voltage	Beam Angle
1x6W	CREE COB	Single	IK05	380lm	12/24 VDC/220-240VAC	15-60°

### 3080R1\*b-B3-B2

Power	LED	CCT	IK	Luminous	Input Voltage	Beam Angle
1x12W	CREE COB	Single	IK05	940lm	24 VDC/220-240VAC	15-60°

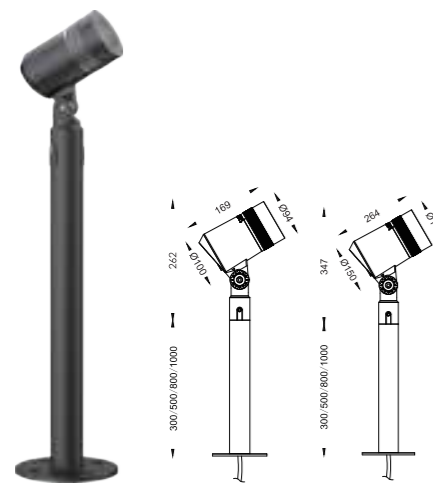

### 3100R1\*b-B3-M2

Power	LED	CCT	IK	Luminous	Input Voltage	Beam Angle
1x18W	CREE COB	Single	IK05	1420lm	24 VDC/220-240VAC	15-60°

### 3150R1\*b-B3-M2

Power	LED	CCT	IK	Luminous	Input Voltage	Beam Angle
1x40W	CREE COB	Single	IK05	2500lm	24 VDC/220-240VAC	15-60°

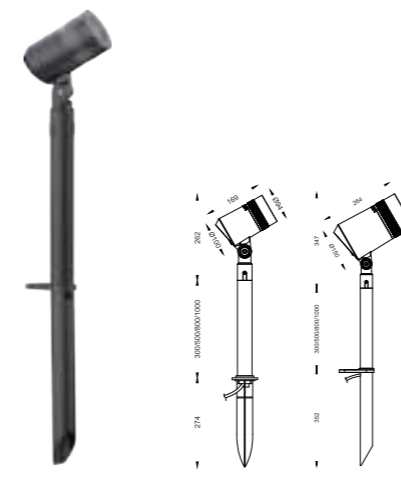

### 3100R1\*b-B3-B2

Power	LED	CCT	IK	Luminous	Input Voltage	Beam Angle
1x18W	CREE COB	Single	IK05	1420lm	24 VDC/220-240VAC	15-60°

### 3150R1\*b-B3-B2

Power	LED	CCT	IK	Luminous	Input Voltage	Beam Angle
1x40W	CREE COB	Single	IK05	2500lm	24 VDC/220-240VAC	15-60°



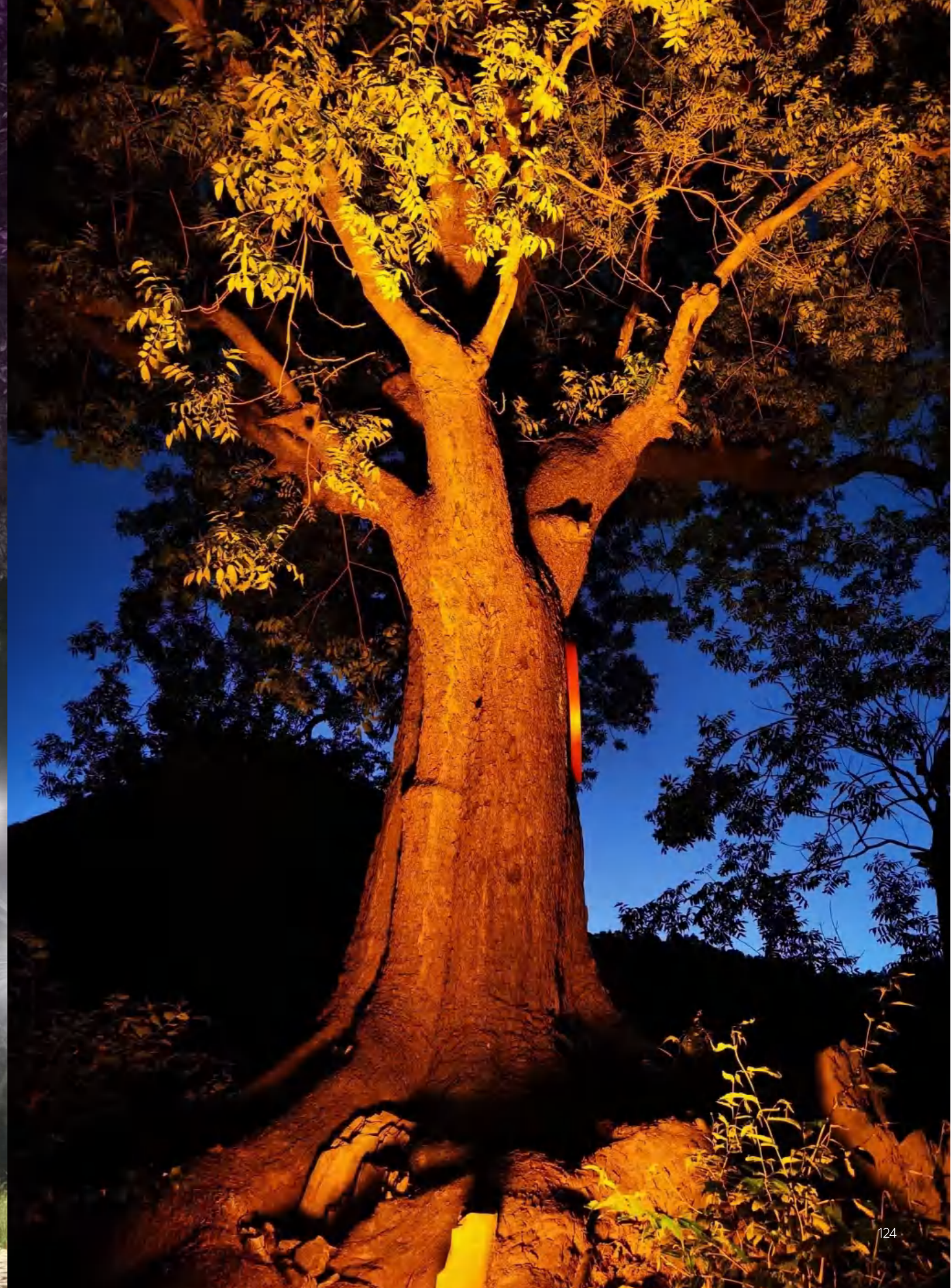

## LED Landscape Spot Light -- Series LP



### 3060R1\* $\alpha$ -XX-M

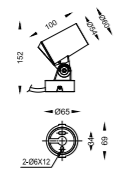

Power	LED	CCT	IK	Luminous	Input Voltage	Beam Angle
1x5W	CREE	Single	IK05	350lm	12/24 VDC/220-240VAC	3°/8°
3x2W	OSRAM/CREE	Single	IK05	330lm	12/24 VDC/220-240VAC	15°/25°/40°/60°/10°60°/20°55°
1x6W	CREE COB	Single	IK05	600lm	12/24 VDC/220-240VAC	18°/24°/38°/60°
3x3W	OSRAM	RGB 3in 1	IK05	128lm	12/24 VDC	25°/40°/60°
3x4W	OSRAM	RGBW 4in 1	IK05	168lm	12/24 VDC	25°/40°/60°

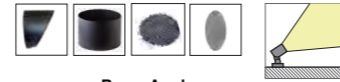

### 3060R1\* $\alpha$ -XX-B

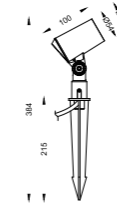

Power	LED	CCT	IK	Luminous	Input Voltage	Beam Angle
1x5W	CREE	Single	IK05	350lm	12/24 VDC/220-240VAC	3°/8°
3x2W	OSRAM/CREE	Single	IK05	330lm	12/24 VDC/220-240VAC	15°/25°/40°/60°/10°60°/20°55°
1x6W	CREE COB	Single	IK05	600lm	12/24 VDC/220-240VAC	18°/24°/38°/60°
3x3W	OSRAM	RGB 3in 1	IK05	128lm	12/24 VDC	25°/40°/60°
3x4W	OSRAM	RGBW 4in 1	IK05	168lm	12/24 VDC	25°/40°/60°



### 3080R1\* $\alpha$ -XX-M

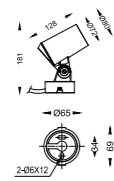

Power	LED	CCT	IK	Luminous	Input Voltage	Beam Angle
1x10W	CREE	Single	IK05	750lm	12/24 VDC/220-240VAC	3°/8°
4x3W	OSRAM/CREE	Single	IK05	780lm	12/24 VDC/220-240VAC	15°/25°/40°/60°/10°60°/20°55°
1x13W	CREE COB	Single	IK05	1310lm	24 VDC/220-240VAC	18°/24°/38°/60°
4x3W	OSRAM	RGB 3in 1	IK05	168lm	12/24 VDC/220-240VAC	25°/40°/60°
4x3.5W	OSRAM	RGBW 4in 1	IK05	224lm	12/24 VDC/220-240VAC	25°/40°/60°

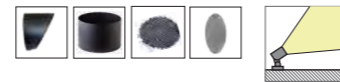

### 3080R1\* $\alpha$ -XX-B

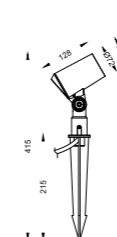

Power	LED	CCT	IK	Luminous	Input Voltage	Beam Angle
1x10W	CREE	Single	IK05	750lm	12/24 VDC/220-240VAC	3°/8°
4x3W	OSRAM/CREE	Single	IK05	780lm	12/24 VDC/220-240VAC	15°/25°/40°/60°/10°60°/20°55°
1x13W	CREE COB	Single	IK05	1310lm	24 VDC/220-240VAC	18°/24°/38°/60°
4x3W	OSRAM	RGB 3in 1	IK05	168lm	12/24 VDC/220-240VAC	25°/40°/60°
4x3.5W	OSRAM	RGBW 4in 1	IK05	224lm	12/24 VDC/220-240VAC	25°/40°/60°

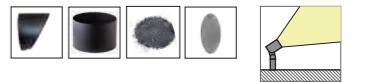

### 3100R1\* $\alpha$ -XX-M

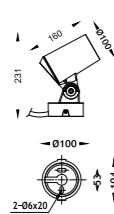

Power	LED	CCT	IK	Luminous	Input Voltage	Beam Angle
3x5W	CREE	Single	IK05	1140lm	12/24 VDC/220-240VAC	3°/8°
6x3W	OSRAM/CREE	Single	IK05	1200lm	12/24 VDC/220-240VAC	15°/25°/40°/60°/10°60°/20°55°
1x20W	CREE COB	Single	IK05	2200lm	24 VDC/220-240VAC	18°/24°/38°/60°
6x2.5W	OSRAM	RGB 3in 1	IK05	360lm	12/24 VDC/220-240VAC	25°/40°/60°
6x3.5W	OSRAM	RGBW 4in 1	IK05	480lm	12/24 VDC/220-240VAC	25°/40°/60°

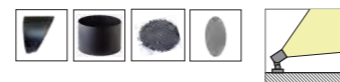

### 3100R1\* $\alpha$ -XX-B

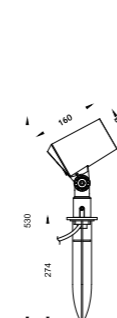

Power	LED	CCT	IK	Luminous	Input Voltage	Beam Angle
3x5W	CREE	Single	IK05	1140lm	12/24 VDC/220-240VAC	3°/8°
6x3W	OSRAM/CREE	Single	IK05	1200lm	12/24 VDC/220-240VAC	15°/25°/40°/60°/10°60°/20°55°
1x20W	CREE COB	Single	IK05	2200lm	24 VDC/220-240VAC	18°/24°/38°/60°
6x2.5W	OSRAM	RGB 3in 1	IK05	360lm	12/24 VDC/220-240VAC	25°/40°/60°
6x3.5W	OSRAM	RGBW 4in 1	IK05	480lm	12/24 VDC/220-240VAC	25°/40°/60°

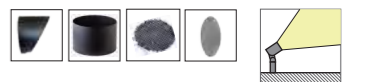

### 3150R1\* $\alpha$ -XX-M

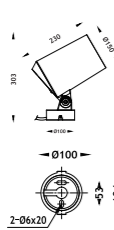

Power	LED	CCT	IK	Luminous	Input Voltage	Beam Angle
6x7W	CREE	Single	IK05	2520lm	12/24 VDC/220-240VAC	3°/8°
12x3.5W	OSRAM/CREE	Single	IK05	2520lm	12/24 VDC/220-240VAC	15°/25°/40°/60°/10°60°/20°55°
1x40W	CREE COB	Single	IK05	3800lm	24 VDC/220-240VAC	18°/24°/38°/60°
12x2.5W	OSRAM	RGB 3in 1	IK05	660lm	12/24 VDC/220-240VAC	25°/40°/60°
12x3.5W	OSRAM	RGBW 4in 1	IK05	990lm	12/24 VDC/220-240VAC	25°/40°/60°

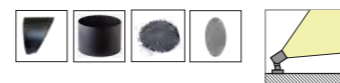

### 3150R1\* $\alpha$ -XX-B

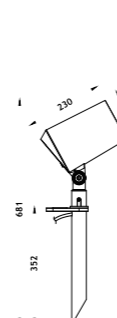

Power	LED	CCT	IK	Luminous	Input Voltage	Beam Angle
6x7W	CREE	Single	IK05	2520lm	12/24 VDC/220-240VAC	3°/8°
12x3.5W	OSRAM/CREE	Single	IK05	2520lm	12/24 VDC/220-240VAC	15°/25°/40°/60°/10°60°/20°55°
1x40W	CREE COB	Single	IK05	3800lm	24 VDC/220-240VAC	18°/24°/38°/60°
12x2.5W	OSRAM	RGB 3in 1	IK05	660lm	12/24 VDC/220-240VAC	25°/40°/60°
12x3.5W	OSRAM	RGBW 4in 1	IK05	990lm	12/24 VDC/220-240VAC	25°/40°/60°

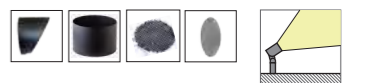

## LED Landscape Spot Light -- Series LP

CE ENEC IP66 RoHS 1-10V Triac PWM DALI RGBW

### 3060R1\* $\alpha$ -XX-H

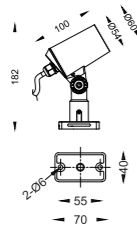
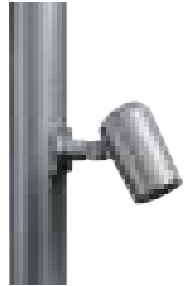

Power	LED	CCT	IK	Luminous	Input Voltage	Beam Angle
1x5W	CREE	Single	IK05	350lm	12/24 VDC/220-240VAC	3°/8°
3x2W	OSRAM/CREE	Single	IK05	330lm	12/24 VDC/220-240VAC	15°/25°/40°/60°/10°/60°/20°/55°
1x6W	CREE COB	Single	IK05	600lm	12/24 VDC/220-240VAC	18°/24°/38°/60°
3x3W	OSRAM	RGB 3in 1	IK05	128lm	12/24 VDC	25°/40°/60°
3x4W	OSRAM	RGBW 4in 1	IK05	168lm	12/24 VDC	25°/40°/60°

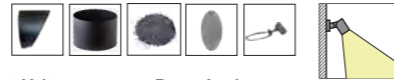

### 3100R1\* $\alpha$ -XX-H2

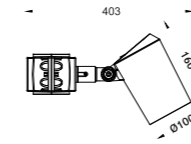

Power	LED	CCT	IK	Luminous	Input Voltage	Beam Angle
3x5W	CREE	Single	IK05	1140lm	12/24 VDC/220-240VAC	3°/8°
6x3W	OSRAM/CREE	Single	IK05	1200lm	12/24 VDC/220-240VAC	15°/25°/40°/60°/10°/60°/20°/55°
1x20W	CREE COB	Single	IK05	2200lm	24 VDC/220-240VAC	18°/24°/38°/60°
6x2.5W	OSRAM	RGB 3in 1	IK05	360lm	12/24 VDC/220-240VAC	25°/40°/60°
6x3.5W	OSRAM	RGBW 4in 1	IK05	480lm	12/24 VDC/220-240VAC	25°/40°/60°

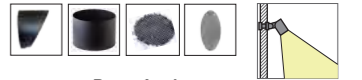

### 3080R1\* $\alpha$ -XX-H

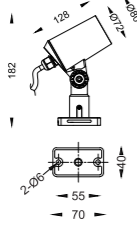
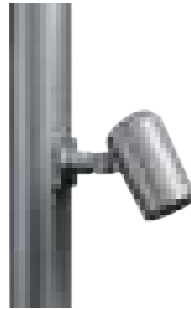

Power	LED	CCT	IK	Luminous	Input Voltage	Beam Angle
1x10W	CREE	Single	IK05	750lm	12/24 VDC/220-240VAC	3°/8°
4x3W	OSRAM/CREE	Single	IK05	780lm	12/24 VDC/220-240VAC	15°/25°/40°/60°/10°/60°/20°/55°
1x13W	CREE COB	Single	IK05	1310lm	24 VDC/220-240VAC	18°/24°/38°/60°
4x3W	OSRAM	RGB 3in 1	IK05	168lm	12/24 VDC/220-240VAC	25°/40°/60°
4x3.5W	OSRAM	RGBW 4in 1	IK05	224lm	12/24 VDC/220-240VAC	25°/40°/60°

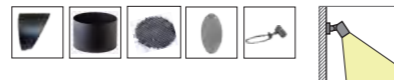

### 3150R1\* $\alpha$ -XX-H2

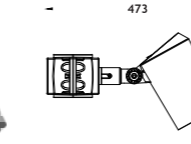

Power	LED	CCT	IK	Luminous	Input Voltage	Beam Angle
6x7W	CREE	Single	IK05	2520lm	12/24 VDC/220-240VAC	3°/8°
12x3.5W	OSRAM/CREE	Single	IK05	2520lm	12/24 VDC/220-240VAC	15°/25°/40°/60°/10°/60°/20°/55°
1x40W	CREE COB	Single	IK05	3800lm	24 VDC/220-240VAC	18°/24°/38°/60°
12x2.5W	OSRAM	RGB 3in 1	IK05	660lm	12/24 VDC/220-240VAC	25°/40°/60°
12x3.5W	OSRAM	RGBW 4in 1	IK05	990lm	12/24 VDC/220-240VAC	25°/40°/60°

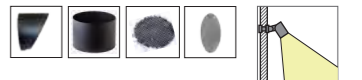

### 3100R1\* $\alpha$ -XX-H

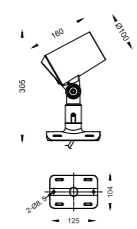
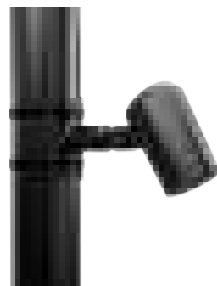

Power	LED	CCT	IK	Luminous	Input Voltage	Beam Angle
3x5W	CREE	Single	IK05	1140lm	12/24 VDC/220-240VAC	3°/8°
6x3W	OSRAM/CREE	Single	IK05	1200lm	12/24 VDC/220-240VAC	15°/25°/40°/60°/10°/60°/20°/55°
1x20W	CREE COB	Single	IK05	2200lm	24 VDC/220-240VAC	18°/24°/38°/60°
6x2.5W	OSRAM	RGB 3in 1	IK05	360lm	12/24 VDC/220-240VAC	25°/40°/60°
6x3.5W	OSRAM	RGBW 4in 1	IK05	480lm	12/24 VDC/220-240VAC	25°/40°/60°

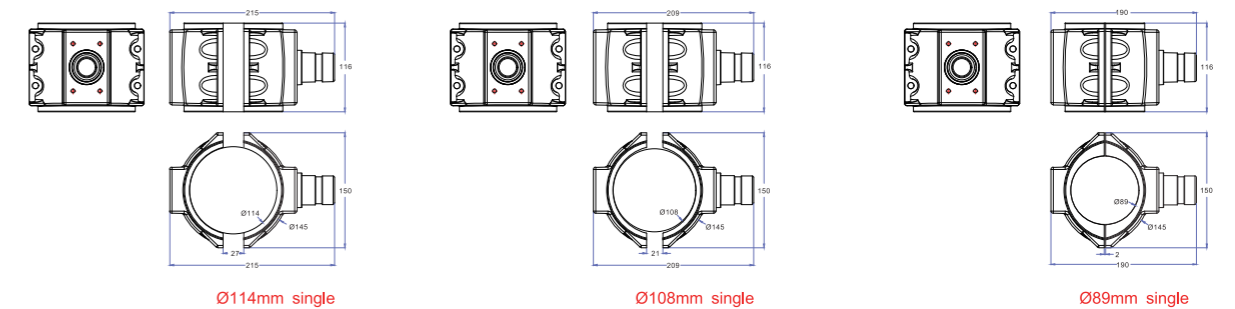
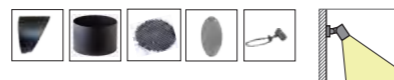

### 3150R1\* $\alpha$ -XX-H

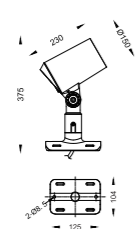
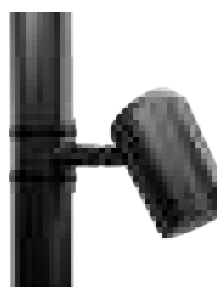

Power	LED	CCT	IK	Luminous	Input Voltage	Beam Angle
6x7W	CREE	Single	IK05	2520lm	12/24 VDC/220-240VAC	3°/8°
12x3.5W	OSRAM/CREE	Single	IK05	2520lm	12/24 VDC/220-240VAC	15°/25°/40°/60°/10°/60°/20°/55°
1x40W	CREE COB	Single	IK05	3800lm	24 VDC/220-240VAC	18°/24°/38°/60°
12x2.5W	OSRAM	RGB 3in 1	IK05	660lm	12/24 VDC/220-240VAC	25°/40°/60°
12x3.5W	OSRAM	RGBW 4in 1	IK05	990lm	12/24 VDC/220-240VAC	25°/40°/60°

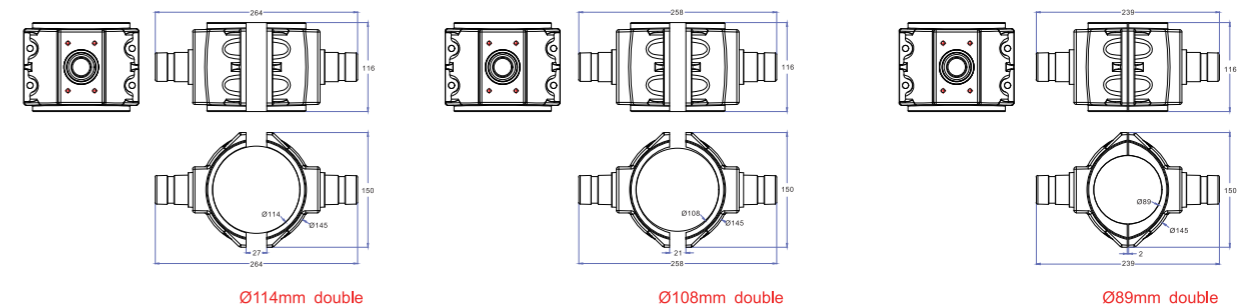
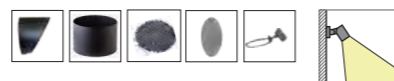

## LED Landscape Spot Light -- Series LP

CE ERP IP66 RoHS 1-10V Triac PWM DALI RGB RGBW

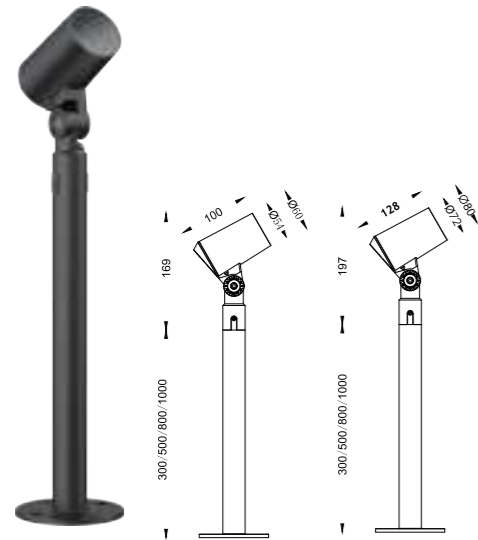

### 3060R1\*a-XX-M2

Power	LED	CCT	IK	Luminous	Input Voltage	Beam Angle
1x5W	CREE	Single	IK05	350lm	12/24 VDC/220-240VAC	3°/8°
3x2W	OSRAM/CREE	Single	IK05	330lm	12/24 VDC/220-240VAC	15°/25°/40°/60°/10°60°/20°55°
1x6W	CREE COB	Single	IK05	600lm	12/24 VDC/220-240VAC	18°/24°/38°/60°
3x3W	OSRAM	RGB 3in 1	IK05	128lm	12/24 VDC	25°/40°/60°
3x4W	OSRAM	RGBW 4in 1	IK05	168lm	12/24 VDC	25°/40°/60°

### 3080R1\*a-XX-M2

Power	LED	CCT	IK	Luminous	Input Voltage	Beam Angle
1x10W	CREE	Single	IK05	750lm	12/24 VDC/220-240VAC	3°/8°
4x3W	OSRAM/CREE	Single	IK05	780lm	12/24 VDC/220-240VAC	15°/25°/40°/60°/10°60°/20°55°
1x13W	CREE COB	Single	IK05	1310lm	24 VDC/220-240VAC	18°/24°/38°/60°
4x3W	OSRAM	RGB 3in 1	IK05	168lm	12/24 VDC/220-240VAC	25°/40°/60°
4x3.5W	OSRAM	RGBW 4in 1	IK05	224lm	12/24 VDC/220-240VAC	25°/40°/60°

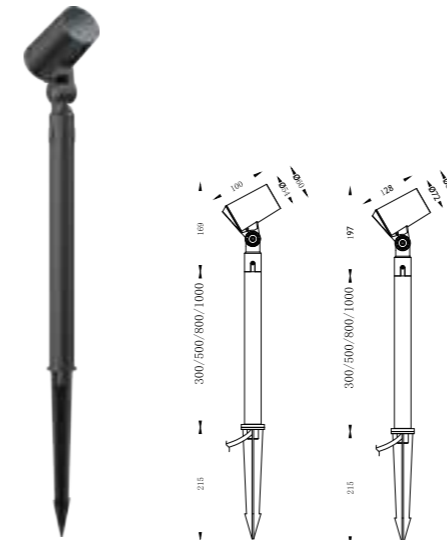

### 3060R1\*a-XX-B2

Power	LED	CCT	IK	Luminous	Input Voltage	Beam Angle
1x5W	CREE	Single	IK05	350lm	12/24 VDC/220-240VAC	3°/8°
3x2W	OSRAM/CREE	Single	IK05	330lm	12/24 VDC/220-240VAC	15°/25°/40°/60°/10°60°/20°55°
1x6W	CREE COB	Single	IK05	600lm	12/24 VDC/220-240VAC	18°/24°/38°/60°
3x3W	OSRAM	RGB 3in 1	IK05	128lm	12/24 VDC	25°/40°/60°
3x4W	OSRAM	RGBW 4in 1	IK05	168lm	12/24 VDC	25°/40°/60°

### 3080R1\*a-XX-B2

Power	LED	CCT	IK	Luminous	Input Voltage	Beam Angle
1x10W	CREE	Single	IK05	750lm	12/24 VDC/220-240VAC	3°/8°
4x3W	OSRAM/CREE	Single	IK05	780lm	12/24 VDC/220-240VAC	15°/25°/40°/60°/10°60°/20°55°
1x13W	CREE COB	Single	IK05	1310lm	24 VDC/220-240VAC	18°/24°/38°/60°
4x3W	OSRAM	RGB 3in 1	IK05	168lm	12/24 VDC/220-240VAC	25°/40°/60°
4x3.5W	OSRAM	RGBW 4in 1	IK05	224lm	12/24 VDC/220-240VAC	25°/40°/60°



### 3100R1\*a-XX-M2

Power	LED	CCT	IK	Luminous	Input Voltage	Beam Angle
3x5W	CREE	Single	IK05	1140lm	12/24 VDC/220-240VAC	3°/8°
6x3W	OSRAM/CREE	Single	IK05	1200lm	12/24 VDC/220-240VAC	15°/25°/40°/60°/10°60°/20°55°
1x20W	CREE COB	Single	IK05	2200lm	24 VDC/220-240VAC	18°/24°/38°/60°
6x2.5W	OSRAM	RGB 3in 1	IK05	360lm	12/24 VDC/220-240VAC	25°/40°/60°
6x3.5W	OSRAM	RGBW 4in 1	IK05	480lm	12/24 VDC/220-240VAC	25°/40°/60°

### 3150R1\*a-XX-M2

Power	LED	CCT	IK	Luminous	Input Voltage	Beam Angle
6x7W	CREE	Single	IK05	2520lm	12/24 VDC/220-240VAC	3°/8°
12x3.5W	OSRAM/CREE	Single	IK05	2520lm	12/24 VDC/220-240VAC	15°/25°/40°/60°/10°60°/20°55°
1x40W	CREE COB	Single	IK05	3800lm	24 VDC/220-240VAC	18°/24°/38°/60°
12x2.5W	OSRAM	RGB 3in 1	IK05	660lm	12/24 VDC/220-240VAC	25°/40°/60°
12x3.5W	OSRAM	RGBW 4in 1	IK05	990lm	12/24 VDC/220-240VAC	25°/40°/60°

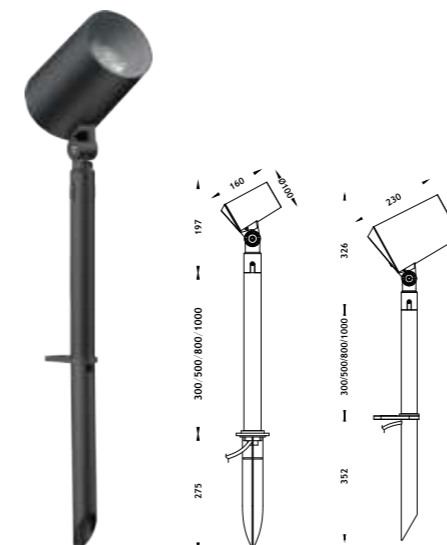

### 3100R1\*a-XX-B2

Power	LED	CCT	IK	Luminous	Input Voltage	Beam Angle
3x5W	CREE	Single	IK05	1140lm	12/24 VDC/220-240VAC	3°/8°
6x3W	OSRAM/CREE	Single	IK05	1200lm	12/24 VDC/220-240VAC	15°/25°/40°/60°/10°60°/20°55°
1x20W	CREE COB	Single	IK05	2200lm	24 VDC/220-240VAC	18°/24°/38°/60°
6x2.5W	OSRAM	RGB 3in 1	IK05	360lm	12/24 VDC/220-240VAC	25°/40°/60°
6x3.5W	OSRAM	RGBW 4in 1	IK05	480lm	12/24 VDC/220-240VAC	25°/40°/60°

### 3150R1\*a-XX-B2

Power	LED	CCT	IK	Luminous	Input Voltage	Beam Angle
6x7W	CREE	Single	IK05	2520lm	12/24 VDC/220-240VAC	3°/8°
12x3.5W	OSRAM/CREE	Single	IK05	2520lm	12/24 VDC/220-240VAC	15°/25°/40°/60°/10°60°/20°55°
1x40W	CREE COB	Single	IK05	3800lm	24 VDC/220-240VAC	18°/24°/38°/60°
12x2.5W	OSRAM	RGB 3in 1	IK05	660lm	12/24 VDC/220-240VAC	25°/40°/60°
12x3.5W	OSRAM	RGBW 4in 1	IK05	990lm	12/24 VDC/220-240VAC	25°/40°/60°

## Series 3H

Spot luminaires stand out for special housing design and high quality optical components specifically for demanding visual tasks to provide enhanced visual comfort.

Housing made of 12# Die-casting aluminum with Akzo powder coated.  
Clear tempered safety glass, transmittance efficiency is over 95% and the accuracy of color temperature as well as strong impact resistance bearing capacity. Quick & simple installation with low maintenance.

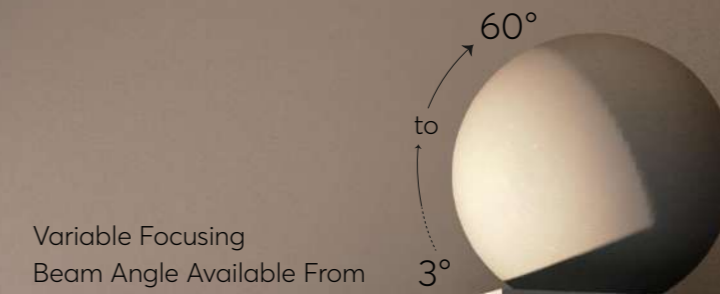

### Elliptical(Asymmetric) Diffusers Angle(FWHM)

Available to all models under Series 3H

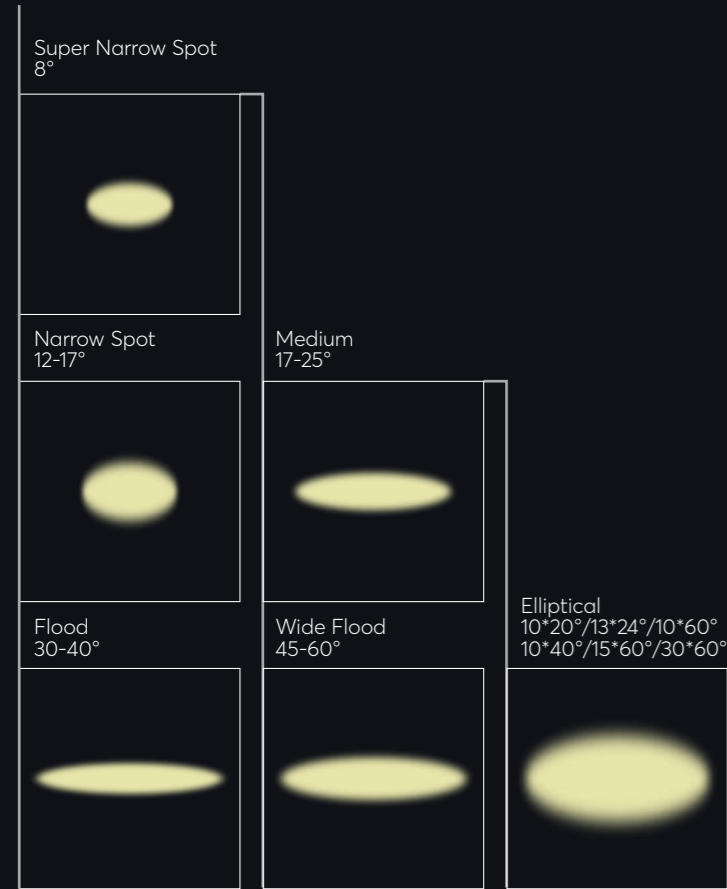

### Lens/Reflector Cup Angle

Available to all models under Series 3H

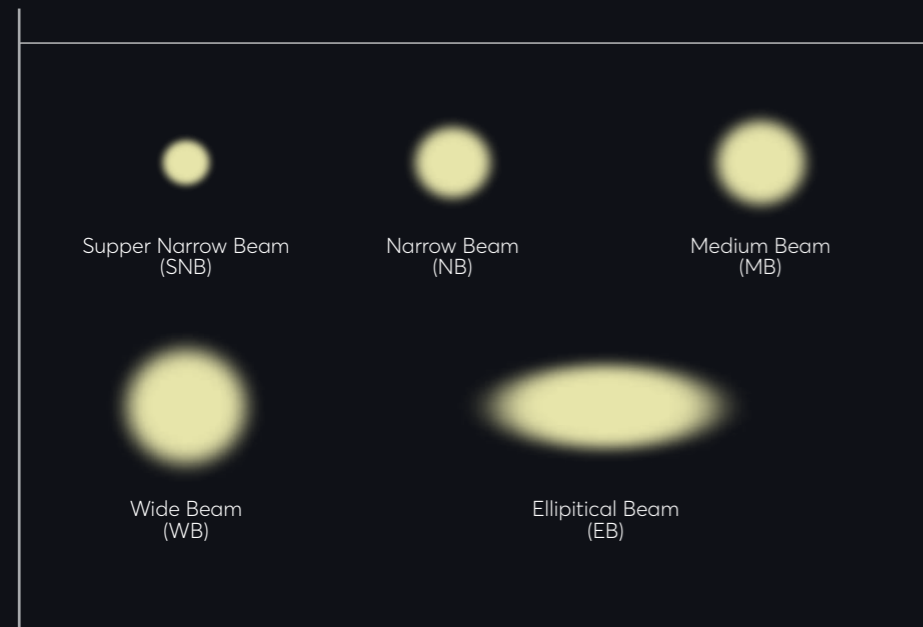

## Series 3H

New LED Spot Light

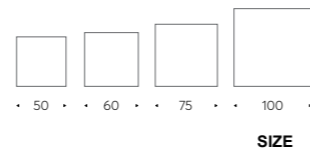

### WB Ovision

WB Spot light series with exemplary design and compact dimensions. With precise optics.

they are used for accent lighting on facades or to illuminate objects from a long distance. The spot light are available in 4 different sizes and wattages. There is a choice of different optics – collimators, wide beam reflectors or an optic for uniform illumination of streets and pathways. The combination of spot lights with different optics makes creative lighting scenarios possible.

Customized: Black, Red, White, etc.



SCENE



PARTS ADDITION

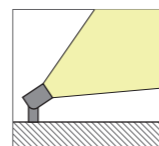

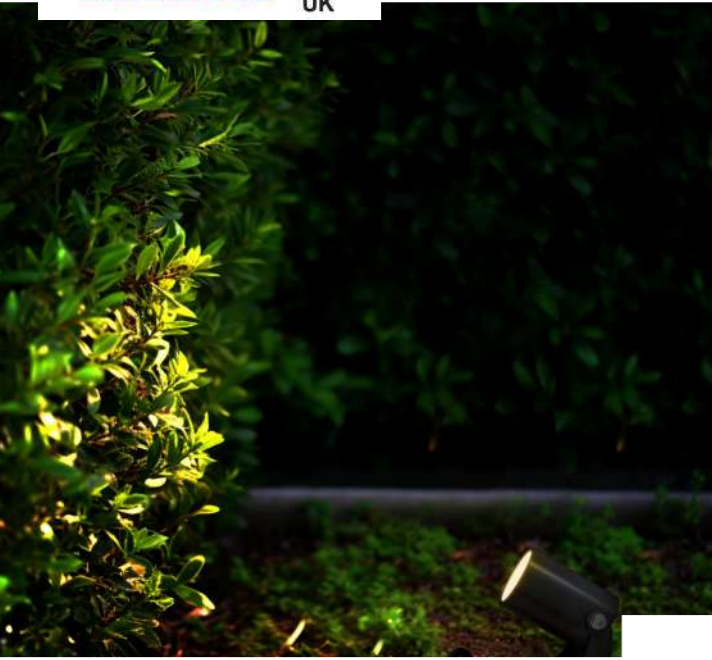

**Series 3H Round Spot Light**

Sturdy construction in order to maintain performance of the luminaire and to reduce maintenance costs.

Comes with a rich range of useful accessories both to solve different types of installation and to control glare.

Applicable for outdoor installation, hotel, villa, facade, garden, residential.



PARTS ADDITION

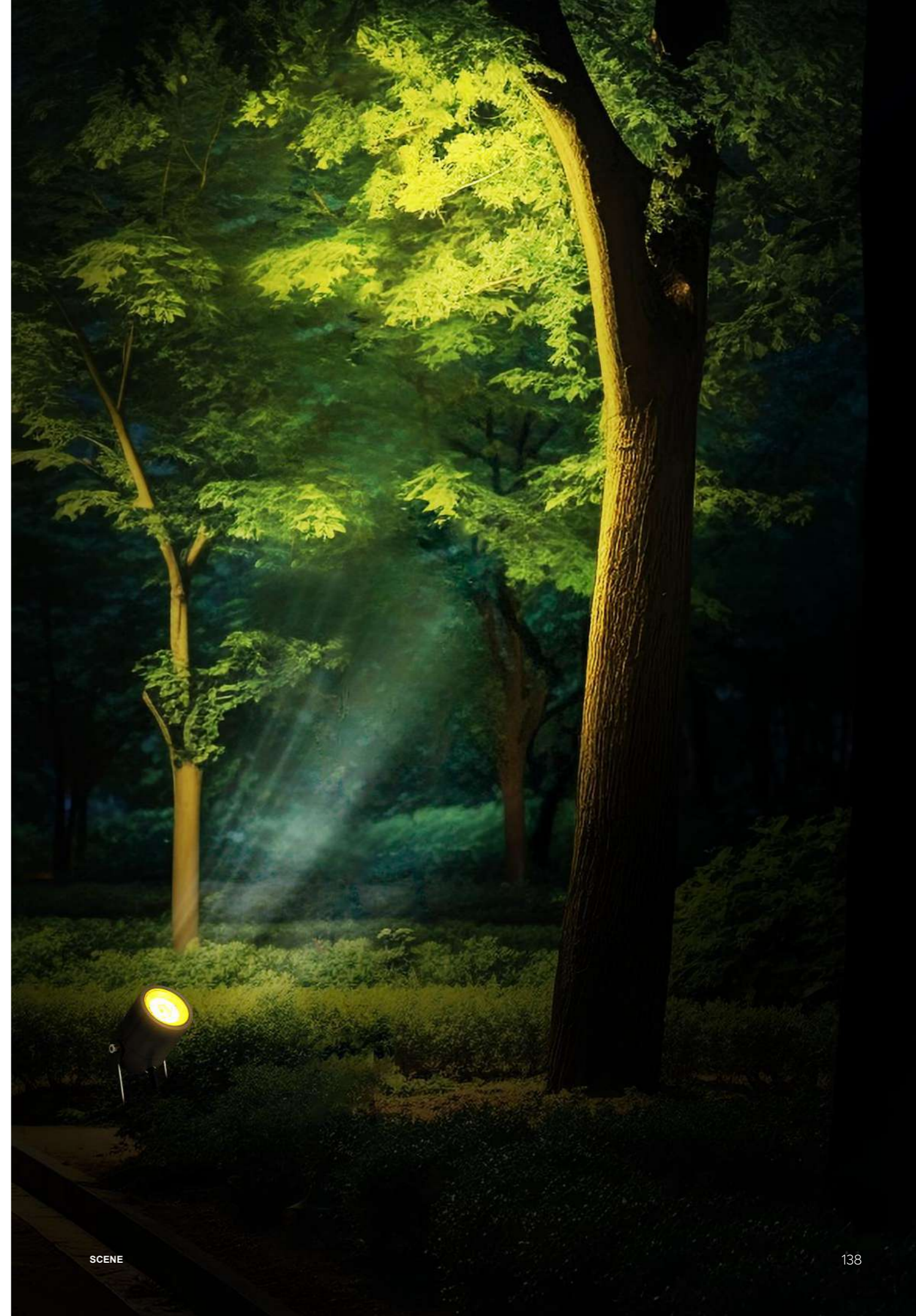
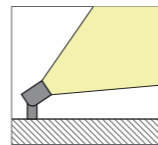

SCENE



## Series 3H Round Spot Light



### 3033R1\*α-A3-Z

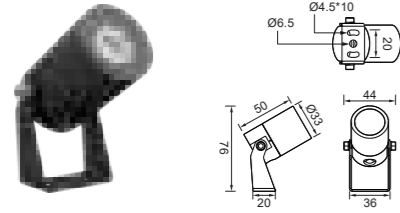

Power LED	Color	IK	Luminous	Input Voltage	Beam Angle
1x2.5W CREE XPE/OSRAM 3030	Black	IK05	--	12/24VDC	5°/10°/15°/20°/30°/40°/60°/10°/45°/25°/45°
	Red	IK05			
	White	IK05			



### 3069R1\*α-B3-Z

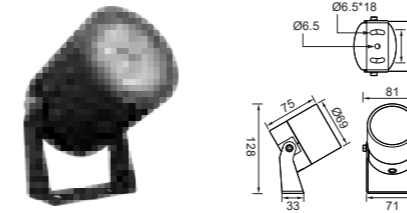

Power LED	Color	IK	Luminous	Input Voltage	Beam Angle
1x10W CREE 1512	Black	IK05	900LM	12/24VDC	12°/24°/36°/55°
	Red	IK05		220-240VAC	
	White	IK05			



### 3043R1\*α-B3-Z

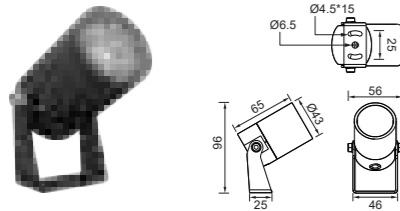

Power LED	Color	IK	Luminous	Input Voltage	Beam Angle
1x4W CREE 1304	Black	IK05	340LM	12/24VDC	15°/24°/36°/55°
	Red	IK05		220-240VAC	
	White	IK05			



### 3085R1\*α-B3-Z

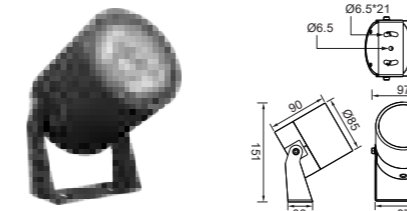

Power LED	Color	IK	Luminous	Input Voltage	Beam Angle
1x15W CREE 1512	Black	IK05	1467LM	12/24VDC	12°/24°/36°/55°
	Red	IK05		220-240VAC	
	White	IK05			



### 3055R1\*α-B3-Z

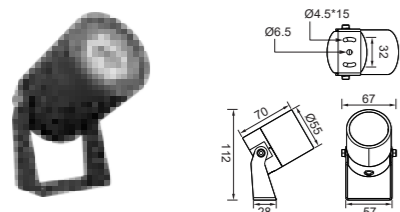

Power LED	Color	IK	Luminous	Input Voltage	Beam Angle
1x6W CREE 1304	Black	IK05	454LM	12/24VDC	15°/24°/36°/55°
	Red	IK05		220-240VAC	
	White	IK05			



### 3105R1\*α-B3-Z

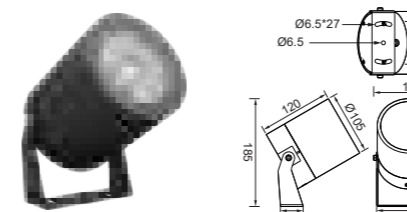

Power LED	Color	IK	Luminous	Input Voltage	Beam Angle
1x23W CREE 1820	Black	IK05	1749LM	12/24VDC	15°/24°/36°/55°
	Red	IK05		220-240VAC	
	White	IK05			



## Series 3H Round Spot Light(Slanted Hat)



### 3033R3\*α-A3-Z

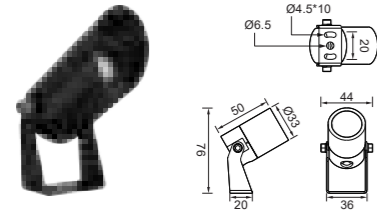

Power LED	Color	IK	Luminous	Input Voltage	Beam Angle
1x2.5W CREE XPE/OSRAM 3030	Black	IK05	--	12/24VDC	5°/10°/15°/20°/30°/40°/60°/10°/45°/25°/45°
	Red	IK05			
	White	IK05			

### 3069R3\*α-B3-Z

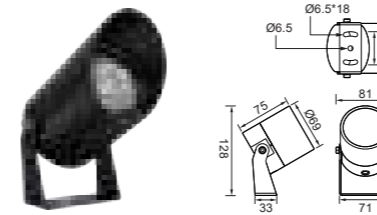

Power LED	Color	IK	Luminous	Input Voltage	Beam Angle
1x10W CREE 1512	Black	IK05	900LM	12/24VDC	12°/24°/36°/55°
	Red	IK05		220-240VAC	
	White	IK05			

### 3043R3\*α-B3-Z

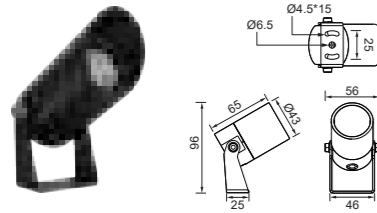

Power LED	Color	IK	Luminous	Input Voltage	Beam Angle
1x4W CREE 1304	Black	IK05	340LM	12/24VDC	15°/24°/36°/55°
	Red	IK05		220-240VAC	
	White	IK05			

### 3085R3\*α-B3-Z

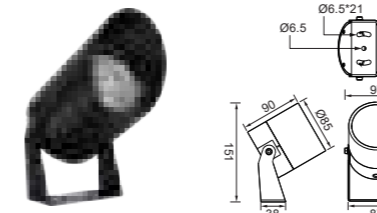

Power LED	Color	IK	Luminous	Input Voltage	Beam Angle
1x15W CREE 1512	Black	IK05	1467LM	12/24VDC	12°/24°/36°/55°
	Red	IK05		220-240VAC	
	White	IK05			

### 3055R3\*α-B3-Z

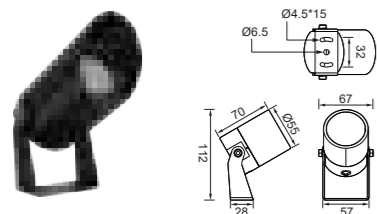

Power LED	Color	IK	Luminous	Input Voltage	Beam Angle
1x6W CREE 1304	Black	IK05	454LM	12/24VDC	15°/24°/36°/55°
	Red	IK05		220-240VAC	
	White	IK05			

### 3105R3\*α-B3-Z

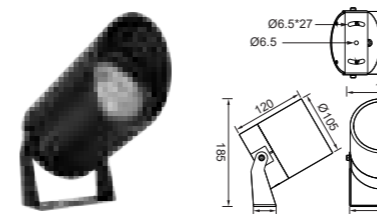

Power LED	Color	IK	Luminous	Input Voltage	Beam Angle
1x23W CREE 1820	Black	IK05	1749LM	12/24VDC	15°/24°/36°/55°
	Red	IK05		220-240VAC	
	White	IK05			

## Series 3H Round Spot Light(Straight Hat)



### 3033R3\*b-B3-Z

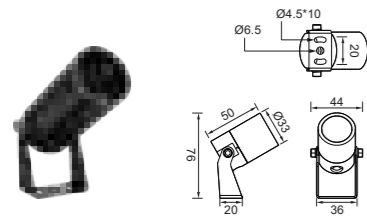

Power LED	Color	IK	Luminous	Input Voltage	Beam Angle
1x2.5W CREE XPE/OSRAM 3030	Black	IK05	--	12/24VDC	5°/10°/15°/20°/30°/40°/60°/10°/45°/25°/45°
	Red	IK05			
	White	IK05			



### 3069R3\*b-B3-Z

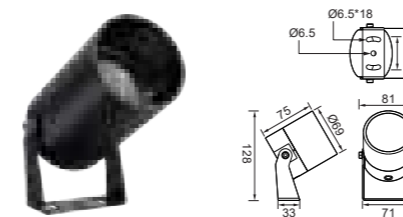

Power LED	Color	IK	Luminous	Input Voltage	Beam Angle
1x10W CREE 1512	Black	IK05	900LM	12/24VDC	12°/24°/36°/55°
	Red	IK05		220-240VAC	
	White	IK05			



### 3043R3\*b-B3-Z

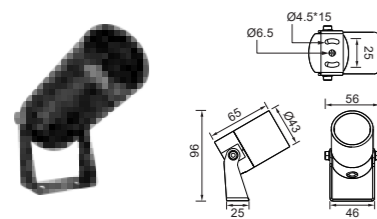

Power LED	Color	IK	Luminous	Input Voltage	Beam Angle
1x4W CREE 1304	Black	IK05	340LM	12/24VDC	15°/24°/36°/55°
	Red	IK05		220-240VAC	
	White	IK05			



### 3085R3\*b-B3-Z

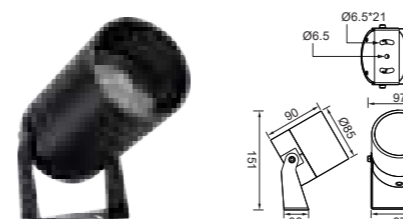

Power LED	Color	IK	Luminous	Input Voltage	Beam Angle
1x15W CREE 1512	Black	IK05	1467LM	12/24VDC	12°/24°/36°/55°
	Red	IK05		220-240VAC	
	White	IK05			



### 3055R3\*b-B3-Z

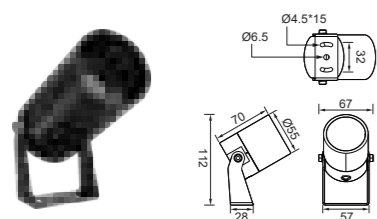

Power LED	Color	IK	Luminous	Input Voltage	Beam Angle
1x6W CREE 1304	Black	IK05	454LM	12/24VDC	15°/24°/36°/55°
	Red	IK05		220-240VAC	
	White	IK05			



### 3105R3\*b-B3-Z

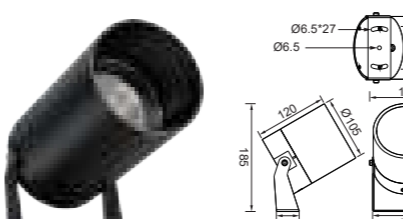

Power LED	Color	IK	Luminous	Input Voltage	Beam Angle
1x23W CREE 1820	Black	IK05	1749LM	12/24VDC	15°/24°/36°/55°
	Red	IK05		220-240VAC	
	White	IK05			





## Series 3H Square Spot Light

CE ErP IP65 RoHS 1-10V Triac PWM DALI RGB RGBW

### 3050S2\*α-B3-Z

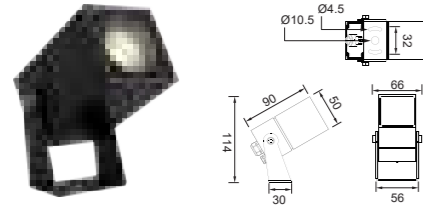

Power LED	Color	IK	Luminous	Input Voltage	Beam Angle
1x6W CREE 1304	Black	IK05	--	12/24VDC	15°/24°/36°/55°
	Red	IK05		220-240VAC	
	White	IK05			



### 3075S2\*α-B3-Z

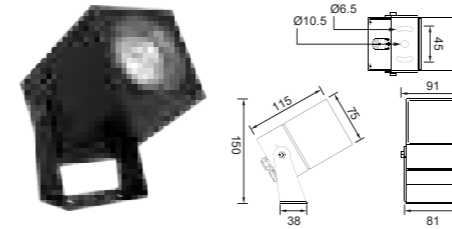

Power LED	Color	IK	Luminous	Input Voltage	Beam Angle
1x6W CREE 1512	Black	IK05	1232LM/1360LM	12/24VDC	15°/24°/36°/55°
	Red	IK05		220-240VAC	
	White	IK05			



### 3060S2\*α-B3-Z

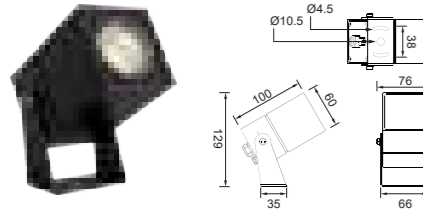

Power LED	Color	IK	Luminous	Input Voltage	Beam Angle
1x10W CREE 1512	Black	IK05	1050LM	12/24VDC	12°/24°/36°/55°
	Red	IK05		220-240VAC	
	White	IK05			



### 3100S2\*α-B3-Z

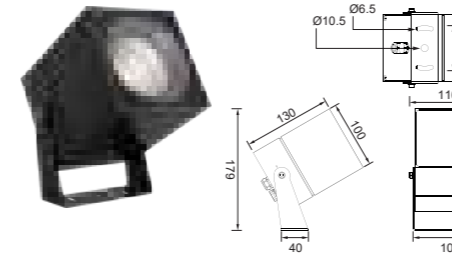

Power LED	Color	IK	Luminous	Input Voltage	Beam Angle
1x23W CREE 1820	Black	IK05	1749LM	12/24VDC	10°/24°/36°/55°
	Red	IK05		220-240VAC	
	White	IK05			



## Series 3H Square Spot Light(Slanted Hat)

CE ErP IP65 RoHS 1-10V Triac PWM DALI RGB RGBW

### 3050S3\*α-B3-Z

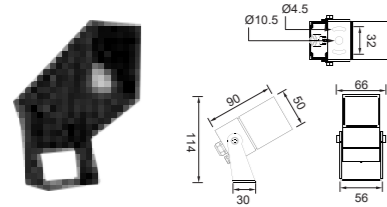

Power LED	Color	IK	Luminous	Input Voltage	Beam Angle
1x6W CREE 1304	Black	IK05	--	12/24VDC	15°/24°/36°/55°
	Red	IK05		220-240VAC	
	White	IK05			



### 3075S3\*α-B3-Z

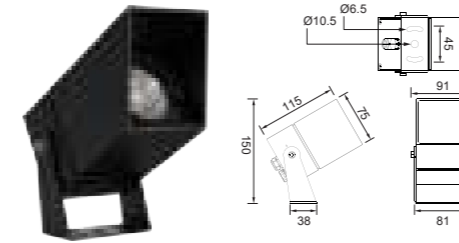

Power LED	Color	IK	Luminous	Input Voltage	Beam Angle
1x6W CREE 1512	Black	IK05	1232LM/1360LM	12/24VDC	15°/24°/36°/55°
	Red	IK05		220-240VAC	
	White	IK05			



### 3060S3\*α-B3-Z

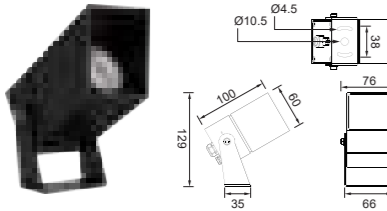

Power LED	Color	IK	Luminous	Input Voltage	Beam Angle
1x10W CREE 1512	Black	IK05	1050LM	12/24VDC	12°/24°/36°/55°
	Red	IK05		220-240VAC	
	White	IK05			



### 3100S3\*α-B3-Z

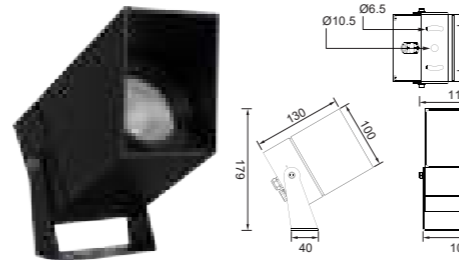

Power LED	Color	IK	Luminous	Input Voltage	Beam Angle
1x23W CREE 1820	Black	IK05	1749LM	12/24VDC	10°/24°/36°/55°
	Red	IK05		220-240VAC	
	White	IK05			



## Series 3H Square Spot Light(Straight Hat)

CE ErP IP65 RoHS 1-10V Triac PWM DALI RGB RGBW

### 3050S3\*b-B3-Z

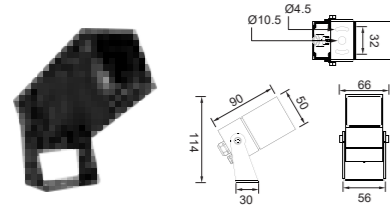

Power LED	Color	IK	Luminous	Input Voltage	Beam Angle
1x6W CREE 1304	Black	IK05	--	12/24VDC	15°/24°/36°/55°
	Red	IK05		220-240VAC	
	White	IK05			



### 3075S3\*b-B3-Z

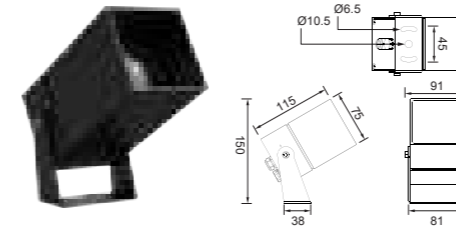

Power LED	Color	IK	Luminous	Input Voltage	Beam Angle
1x6W CREE 1512	Black	IK05	1232LM/1360LM	12/24VDC	15°/24°/36°/55°
	Red	IK05		220-240VAC	
	White	IK05			



### 3060S3\*b-B3-Z

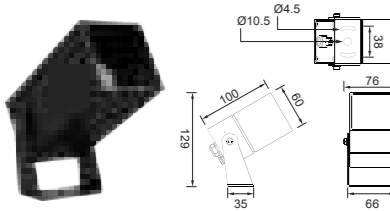

Power LED	Color	IK	Luminous	Input Voltage	Beam Angle
1x10W CREE 1512	Black	IK05	1050LM	12/24VDC	12°/24°/36°/55°
	Red	IK05		220-240VAC	
	White	IK05			



### 3100S3\*b-B3-Z

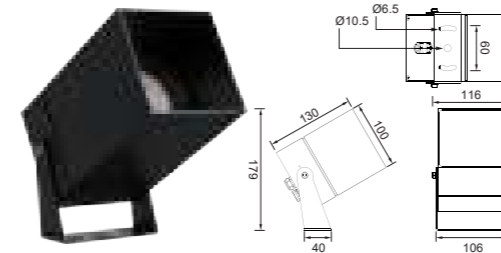

Power LED	Color	IK	Luminous	Input Voltage	Beam Angle
1x23W CREE 1820	Black	IK05	1749LM	12/24VDC	10°/24°/36°/55°
	Red	IK05		220-240VAC	
	White	IK05			



## LED Landscape Spot Light



### 3045R3\*α-XX-M

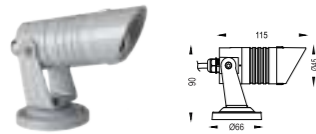

Power	LED	CCT	IK	Luminous	Input Voltage	Beam Angle
1x4W	OSRAM/CREE	Single	IK04	380lm	12/24 VDC/220-240VAC	5°/8°/10°/30°/40°/60°
1x6W	CREE COB	Single	IK04	465lm	12/24 VDC/220-240VAC	15°/24°/36°/55°
1x3W	OSRAM	RGB 3in 1	IK04	60lm	12/24 VDC	20°/30°/40°/60°
1x4W	OSRAM	RGBW 4in 1	IK04	80lm	12/24 VDC	20°/30°/40°/60°

### 3045R3\*α-XX-B



Power	LED	CCT	IK	Luminous	Input Voltage	Beam Angle
1x4W	OSRAM/CREE	Single	IK04	380lm	12/24 VDC/220-240VAC	5°/8°/10°/30°/40°/60°
1x6W	CREE COB	Single	IK04	465lm	12/24 VDC/220-240VAC	15°/24°/36°/55°
1x3W	OSRAM	RGB 3in 1	IK04	60lm	12/24 VDC	20°/30°/40°/60°
1x4W	OSRAM	RGBW 4in 1	IK04	80lm	12/24 VDC	20°/30°/40°/60°

### 3065R3\*α-XX-M

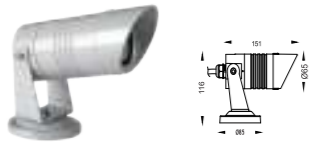

Power	LED	CCT	IK	Luminous	Input Voltage	Beam Angle
3x4W	OSRAM/CREE	Single	IK04	960lm	12/24 VDC/220-240VAC	8°/10°/30°/40°/60°
1x12W	CREE COB	Single	IK04	1260lm	12/24 VDC/220-240VAC	15°/24°/36°/55°
3x2.5W	OSRAM	RGB 3in 1	IK04	220lm	12/24 VDC	20°/30°/40°/60°
3x3.5W	OSRAM	RGBW 4in 1	IK04	260lm	12/24 VDC	20°/30°/40°/60°

### 3065R3\*α-XX-B



Power	LED	CCT	IK	Luminous	Input Voltage	Beam Angle
3x4W	OSRAM/CREE	Single	IK04	960lm	12/24 VDC/220-240VAC	8°/10°/30°/40°/60°
1x12W	CREE COB	Single	IK04	1260lm	12/24 VDC/220-240VAC	15°/24°/36°/55°
3x2.5W	OSRAM	RGB 3in 1	IK04	220lm	12/24 VDC	20°/30°/40°/60°
3x3.5W	OSRAM	RGBW 4in 1	IK04	260lm	12/24 VDC	20°/30°/40°/60°

### 3075R3\*α-XX-M



Power	LED	CCT	IK	Luminous	Input Voltage	Beam Angle
4x4W	OSRAM/CREE	Single	IK04	1280lm	12/24 VDC/220-240VAC	8°/10°/30°/40°/60°
1x16W	CREE COB	Single	IK04	1840lm	12/24 VDC/220-240VAC	15°/24°/36°/55°
4x2.5W	OSRAM	RGB 3in 1	IK04	250lm	12/24 VDC	20°/30°/40°/60°
4x3.5W	OSRAM	RGBW 4in 1	IK04	350lm	12/24 VDC	20°/30°/40°/60°

### 3075R3\*α-XX-B



Power	LED	CCT	IK	Luminous	Input Voltage	Beam Angle
4x4W	OSRAM/CREE	Single	IK04	1280lm	12/24 VDC/220-240VAC	8°/10°/30°/40°/60°
1x16W	CREE COB	Single	IK04	1840lm	12/24 VDC/220-240VAC	15°/24°/36°/55°
4x2.5W	OSRAM	RGB 3in 1	IK04	250lm	12/24 VDC	20°/30°/40°/60°
4x3.5W	OSRAM	RGBW 4in 1	IK04	350lm	12/24 VDC	20°/30°/40°/60°

# LED Landscape Spot Light



## 3045R1\*α-XX-M

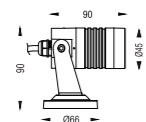

Power	LED	CCT	IK	Luminous	Input Voltage	Beam Angle
1x4W	OSRAM/CREE	Single	IK04	380lm	12/24 VDC/220-240VAC	5°/8°/10°/30°/40°/60°
1x6W	CREE COB	Single	IK04	465lm	12/24 VDC/220-240VAC	15°/24°/36°/55°
1x3W	OSRAM	RGB 3in 1	IK04	60lm	12/24 VDC	20°/30°/40°/60°
1x4W	OSRAM	RGBW 4in 1	IK04	80lm	12/24 VDC	20°/30°/40°/60°

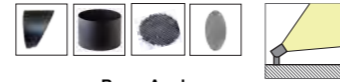

## 3045R1\*α-XX-B

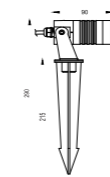

Power	LED	CCT	IK	Luminous	Input Voltage	Beam Angle
1x4W	OSRAM/CREE	Single	IK04	380lm	12/24 VDC/220-240VAC	5°/8°/10°/30°/40°/60°
1x6W	CREE COB	Single	IK04	465lm	12/24 VDC/220-240VAC	15°/24°/36°/55°
1x3W	OSRAM	RGB 3in 1	IK04	60lm	12/24 VDC	20°/30°/40°/60°
1x4W	OSRAM	RGBW 4in 1	IK04	80lm	12/24 VDC	20°/30°/40°/60°



## 3065R1\*α-XX-M

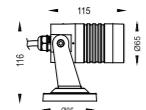

Power	LED	CCT	IK	Luminous	Input Voltage	Beam Angle
3x4W	OSRAM/CREE	Single	IK04	960lm	12/24 VDC/220-240VAC	8°/10°/30°/40°/60°
1x12W	CREE COB	Single	IK04	1260lm	12/24 VDC/220-240VAC	15°/24°/36°/55°
3x2.5W	OSRAM	RGB 3in 1	IK04	220lm	12/24 VDC	20°/30°/40°/60°
3x3.5W	OSRAM	RGBW 4in 1	IK04	260lm	12/24 VDC	20°/30°/40°/60°

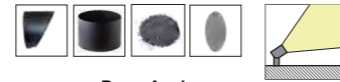

## 3065R1\*α-XX-B

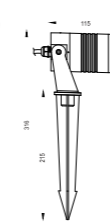

Power	LED	CCT	IK	Luminous	Input Voltage	Beam Angle
3x4W	OSRAM/CREE	Single	IK04	960lm	12/24 VDC/220-240VAC	8°/10°/30°/40°/60°
1x12W	CREE COB	Single	IK04	1260lm	12/24 VDC/220-240VAC	15°/24°/36°/55°
3x2.5W	OSRAM	RGB 3in 1	IK04	220lm	12/24 VDC	20°/30°/40°/60°
3x3.5W	OSRAM	RGBW 4in 1	IK04	260lm	12/24 VDC	20°/30°/40°/60°

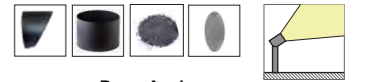

## 3075R1\*α-XX-M

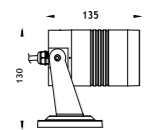

Power	LED	CCT	IK	Luminous	Input Voltage	Beam Angle
4x4W	OSRAM/CREE	Single	IK04	1280lm	12/24 VDC/220-240VAC	8°/10°/30°/40°/60°
1x16W	CREE COB	Single	IK04	1840lm	12/24 VDC/220-240VAC	15°/24°/36°/55°
4x2.5W	OSRAM	RGB 3in 1	IK04	250lm	12/24 VDC	20°/30°/40°/60°
4x3.5W	OSRAM	RGBW 4in 1	IK04	350lm	12/24 VDC	20°/30°/40°/60°

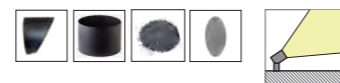

## 3075R1\*α-XX-B

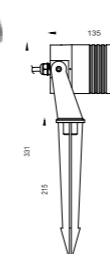

Power	LED	CCT	IK	Luminous	Input Voltage	Beam Angle
4x4W	OSRAM/CREE	Single	IK04	1280lm	12/24 VDC/220-240VAC	8°/10°/30°/40°/60°
1x16W	CREE COB	Single	IK04	1840lm	12/24 VDC/220-240VAC	15°/24°/36°/55°
4x2.5W	OSRAM	RGB 3in 1	IK04	250lm	12/24 VDC	20°/30°/40°/60°
4x3.5W	OSRAM	RGBW 4in 1	IK04	350lm	12/24 VDC	20°/30°/40°/60°

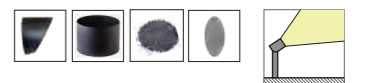



## LED Spot Light

The combination of spot lights with different optics makes creative lighting scenarios possible.



LED High Pole Spot Lights

The Combination >

< Locking Rod

< Hugging Pillar

Spot Light

Website: [WWW.iliteuk.com](http://WWW.iliteuk.com)

Email: [sales@iliteuk.com](mailto:sales@iliteuk.com)

Address: 1 Hatton Street, London, United Kingdom, NW8 8PL

## LED Landscape Spot Light -- Series TW

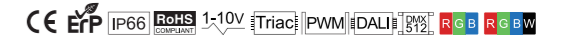

### 3130R1\*a-XX-M

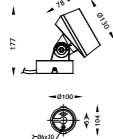

Power	LED	CCT	IK	Luminous	Input Voltage	Beam Angle
3x4W	CREE	Single	IK05	700lm	12/24 VDC/220-240VAC	3°/8°
6x3W	OSRAM/CREE	Single	IK05	1080lm	12/24 VDC/220-240VAC	15°/25°/40°/60°/10°/60°/20°/55°
1x18W	CREE COB	Single	IK05	1520lm	24 VDC/220-240VAC	18°/24°/38°/60°
6x2.5W	OSRAM	RGB 3in 1	IK05	380lm	12/24 VDC/220-240VAC	25°/40°/60°
6x3.5W	OSRAM	RGBW 4in 1	IK05	520lm	12/24 VDC/220-240VAC	25°/40°/60°

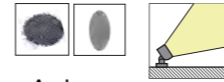

### 3130R1\*a-XX-B

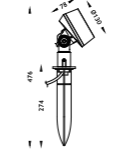

Power	LED	CCT	IK	Luminous	Input Voltage	Beam Angle
3x4W	CREE	Single	IK05	700lm	12/24 VDC/220-240VAC	3°/8°
6x3W	OSRAM/CREE	Single	IK05	1080lm	12/24 VDC/220-240VAC	15°/25°/40°/60°/10°/60°/20°/55°
1x18W	CREE COB	Single	IK05	1520lm	24 VDC/220-240VAC	18°/24°/38°/60°
6x2.5W	OSRAM	RGB 3in 1	IK05	380lm	12/24 VDC/220-240VAC	25°/40°/60°
6x3.5W	OSRAM	RGBW 4in 1	IK05	520lm	12/24 VDC/220-240VAC	25°/40°/60°

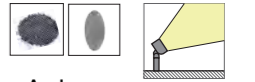

### 3170R1\*a-XX-M

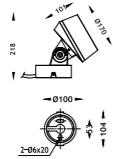

Power	LED	CCT	IK	Luminous	Input Voltage	Beam Angle
6x4W	CREE	Single	IK05	1340lm	12/24 VDC/220-240VAC	3°/8°
12x3W	OSRAM/CREE	Single	IK05	2450lm	12/24 VDC/220-240VAC	15°/25°/40°/60°/10°/60°/20°/55°
1x35W	CREE COB	Single	IK05	3400lm	24 VDC/220-240VAC	18°/24°/38°/60°
12x2.5W	OSRAM	RGB 3in 1	IK05	600lm	12/24 VDC/220-240VAC	25°/40°/60°
12x3.5W	OSRAM	RGBW 4in 1	IK05	840lm	12/24 VDC/220-240VAC	25°/40°/60°



### 3170R1\*a-XX-B

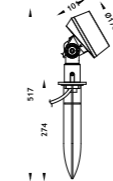

Power	LED	CCT	IK	Luminous	Input Voltage	Beam Angle
6x4W	CREE	Single	IK05	1340lm	12/24 VDC/220-240VAC	3°/8°
12x3W	OSRAM/CREE	Single	IK05	2450lm	12/24 VDC/220-240VAC	15°/25°/40°/60°/10°/60°/20°/55°
1x35W	CREE COB	Single	IK05	3400lm	24 VDC/220-240VAC	18°/24°/38°/60°
12x2.5W	OSRAM	RGB 3in 1	IK05	600lm	12/24 VDC/220-240VAC	25°/40°/60°
12x3.5W	OSRAM	RGBW 4in 1	IK05	840lm	12/24 VDC/220-240VAC	25°/40°/60°

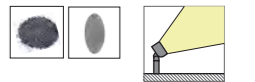

### 3210R1\*a-XX-M

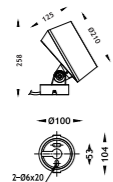

Power	LED	CCT	IK	Luminous	Input Voltage	Beam Angle
12x4W	CREE	Single	IK05	2400lm	12/24 VDC/220-240VAC	3°/8°
24x2W	OSRAM/CREE	Single	IK05	3750lm	12/24 VDC/220-240VAC	15°/25°/40°/60°/10°/60°/20°/55°
4x14W	CREE COB	Single	IK05	4950lm	24 VDC/220-240VAC	18°/24°/38°/60°
24x2.5W	OSRAM	RGB 3in 1	IK05	1500lm	12/24 VDC/220-240VAC	25°/40°/60°
24x3.5W	OSRAM	RGBW 4in 1	IK05	2000lm	12/24 VDC/220-240VAC	25°/40°/60°



### 3210R1\*a-XX-B

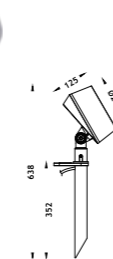

Power	LED	CCT	IK	Luminous	Input Voltage	Beam Angle
12x4W	CREE	Single	IK05	2400lm	12/24 VDC/220-240VAC	3°/8°
24x2W	OSRAM/CREE	Single	IK05	3750lm	12/24 VDC/220-240VAC	15°/25°/40°/60°/10°/60°/20°/55°
4x14W	CREE COB	Single	IK05	4950lm	24 VDC/220-240VAC	18°/24°/38°/60°
24x2.5W	OSRAM	RGB 3in 1	IK05	1500lm	12/24 VDC/220-240VAC	25°/40°/60°
24x3.5W	OSRAM	RGBW 4in 1	IK05	2000lm	12/24 VDC/220-240VAC	25°/40°/60°

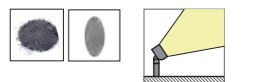

### 3260R1\*a-XX-M

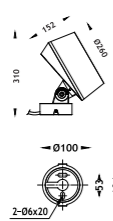

Power	LED	CCT	IK	Luminous	Input Voltage	Beam Angle
18x4W	CREE	Single	IK05	4500lm	12/24 VDC/220-240VAC	3°/8°
36x2W	OSRAM/CREE	Single	IK05	4900lm	12/24 VDC/220-240VAC	15°/25°/40°/60°/10°/60°/20°/55°
4x18W	CREE COB	Single	IK05	6400lm	24 VDC/220-240VAC	18°/24°/38°/60°
36x3W	OSRAM	RGB 3in 1	IK05	2700lm	12/24 VDC/220-240VAC	25°/40°/60°
36x4W	OSRAM	RGBW 4in 1	IK05	3420lm	12/24 VDC/220-240VAC	25°/40°/60°



### 3260R1\*a-XX-B

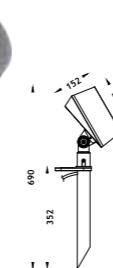

Power	LED	CCT	IK	Luminous	Input Voltage	Beam Angle
18x4W	CREE	Single	IK05	4500lm	12/24 VDC/220-240VAC	3°/8°
36x2W	OSRAM/CREE	Single	IK05	4900lm	12/24 VDC/220-240VAC	15°/25°/40°/60°/10°/60°/20°/55°
4x18W	CREE COB	Single	IK05	6400lm	24 VDC/220-240VAC	18°/24°/38°/60°
36x3W	OSRAM	RGB 3in 1	IK05	2700lm	12/24 VDC/220-240VAC	25°/40°/60°
36x4W	OSRAM	RGBW 4in 1	IK05	3420lm	12/24 VDC/220-240VAC	25°/40°/60°

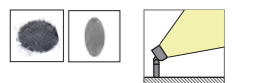

## LED Landscape Spot Light -- Series TW

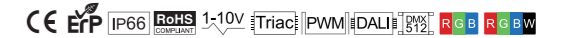

### 3130R1\*a-XX-H

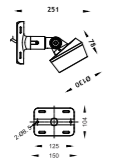
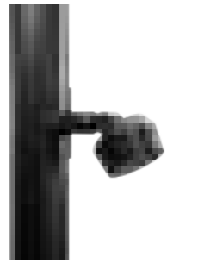

Power	LED	CCT	IK	Luminous	Input Voltage	Beam Angle
3x4W	CREE	Single	IK05	700lm	12/24 VDC/220-240VAC	3°/8°
6x3W	OSRAM/CREE	Single	IK05	1080lm	12/24 VDC/220-240VAC	15°/25°/40°/60°/10°60°/20°55°
1x18W	CREE COB	Single	IK05	1520lm	24 VDC/220-240VAC	18°/24°/38°/60°
6x2.5W	OSRAM	RGB 3in 1	IK05	380lm	12/24 VDC/220-240VAC	25°/40°/60°
6x3.5W	OSRAM	RGBW 4in 1	IK05	520lm	12/24 VDC/220-240VAC	25°/40°/60°

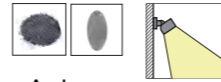

### 3130R1\*a-XX-H2

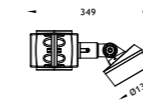

Power	LED	CCT	IK	Luminous	Input Voltage	Beam Angle
3x4W	CREE	Single	IK05	700lm	12/24 VDC/220-240VAC	3°/8°
6x3W	OSRAM/CREE	Single	IK05	1080lm	12/24 VDC/220-240VAC	15°/25°/40°/60°/10°60°/20°55°
1x18W	CREE COB	Single	IK05	1520lm	24 VDC/220-240VAC	18°/24°/38°/60°
6x2.5W	OSRAM	RGB 3in 1	IK05	380lm	12/24 VDC/220-240VAC	25°/40°/60°
6x3.5W	OSRAM	RGBW 4in 1	IK05	520lm	12/24 VDC/220-240VAC	25°/40°/60°

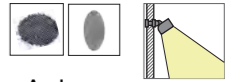

### 3170R1\*a-XX-H

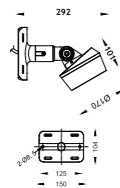
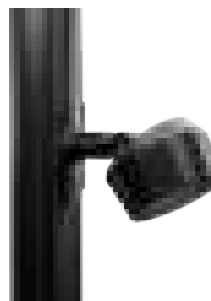

Power	LED	CCT	IK	Luminous	Input Voltage	Beam Angle
6x4W	CREE	Single	IK05	1340lm	12/24 VDC/220-240VAC	3°/8°
12x3W	OSRAM/CREE	Single	IK05	2450lm	12/24 VDC/220-240VAC	15°/25°/40°/60°/10°60°/20°55°
1x35W	CREE COB	Single	IK05	3400lm	24 VDC/220-240VAC	18°/24°/38°/60°
12x2.5W	OSRAM	RGB 3in 1	IK05	600lm	12/24 VDC/220-240VAC	25°/40°/60°
12x3.5W	OSRAM	RGBW 4in 1	IK05	840lm	12/24 VDC/220-240VAC	25°/40°/60°

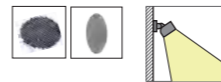

### 3170R1\*a-XX-H2

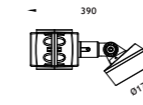

Power	LED	CCT	IK	Luminous	Input Voltage	Beam Angle
6x4W	CREE	Single	IK05	1340lm	12/24 VDC/220-240VAC	3°/8°
12x3W	OSRAM/CREE	Single	IK05	2450lm	12/24 VDC/220-240VAC	15°/25°/40°/60°/10°60°/20°55°
1x35W	CREE COB	Single	IK05	3400lm	24 VDC/220-240VAC	18°/24°/38°/60°
12x2.5W	OSRAM	RGB 3in 1	IK05	600lm	12/24 VDC/220-240VAC	25°/40°/60°
12x3.5W	OSRAM	RGBW 4in 1	IK05	840lm	12/24 VDC/220-240VAC	25°/40°/60°

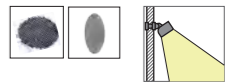

### 3210R1\*a-XX-H

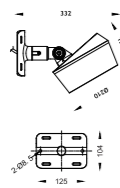
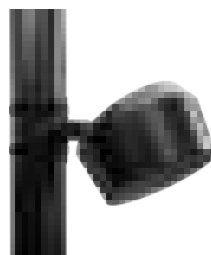

Power	LED	CCT	IK	Luminous	Input Voltage	Beam Angle
12x4W	CREE	Single	IK05	2400lm	12/24 VDC/220-240VAC	3°/8°
24x2W	OSRAM/CREE	Single	IK05	3750lm	12/24 VDC/220-240VAC	15°/25°/40°/60°/10°60°/20°55°
4x14W	CREE COB	Single	IK05	4950lm	24 VDC/220-240VAC	18°/24°/38°/60°
24x2.5W	OSRAM	RGB 3in 1	IK05	1500lm	12/24 VDC/220-240VAC	25°/40°/60°
24x3.5W	OSRAM	RGBW 4in 1	IK05	2000lm	12/24 VDC/220-240VAC	25°/40°/60°

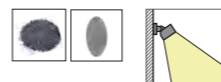

### 3210R1\*a-XX-H2

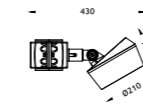

Power	LED	CCT	IK	Luminous	Input Voltage	Beam Angle
12x4W	CREE	Single	IK05	2400lm	12/24 VDC/220-240VAC	3°/8°
24x2W	OSRAM/CREE	Single	IK05	3750lm	12/24 VDC/220-240VAC	15°/25°/40°/60°/10°60°/20°55°
4x14W	CREE COB	Single	IK05	4950lm	24 VDC/220-240VAC	18°/24°/38°/60°
24x2.5W	OSRAM	RGB 3in 1	IK05	1500lm	12/24 VDC/220-240VAC	25°/40°/60°
24x3.5W	OSRAM	RGBW 4in 1	IK05	2000lm	12/24 VDC/220-240VAC	25°/40°/60°

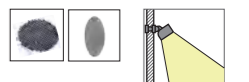

### 3260R1\*a-XX-H

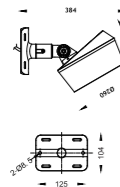
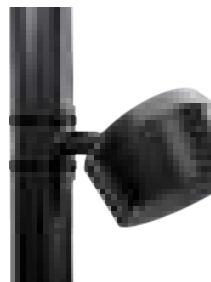

Power	LED	CCT	IK	Luminous	Input Voltage	Beam Angle
18x4W	CREE	Single	IK05	4500lm	12/24 VDC/220-240VAC	3°/8°
36x2W	OSRAM/CREE	Single	IK05	4900lm	12/24 VDC/220-240VAC	15°/25°/40°/60°/10°60°/20°55°
4x18W	CREE COB	Single	IK05	6400lm	24 VDC/220-240VAC	18°/24°/38°/60°
36x3W	OSRAM	RGB 3in 1	IK05	2700lm	12/24 VDC/220-240VAC	25°/40°/60°
36x4W	OSRAM	RGBW 4in 1	IK05	3420lm	12/24 VDC/220-240VAC	25°/40°/60°



### 3260R1\*a-XX-H2

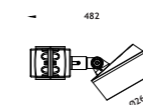

Power	LED	CCT	IK	Luminous	Input Voltage	Beam Angle
18x4W	CREE	Single	IK05	4500lm	12/24 VDC/220-240VAC	3°/8°
36x2W	OSRAM/CREE	Single	IK05	4900lm	12/24 VDC/220-240VAC	15°/25°/40°/60°/10°60°/20°55°
4x18W	CREE COB	Single	IK05	6400lm	24 VDC/220-240VAC	18°/24°/38°/60°
36x3W	OSRAM	RGB 3in 1	IK05	2700lm	12/24 VDC/220-240VAC	25°/40°/60°
36x4W	OSRAM	RGBW 4in 1	IK05	3420lm	12/24 VDC/220-240VAC	25°/40°/60°

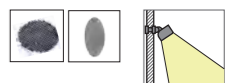

# LED Landscape Spot Light -- Series TW



## 3130R1\*a-XX-M2

Power	LED	CCT	IK	Luminous	Input Voltage	Beam Angle
3x4W	CREE	Single	IK05	700lm	12/24 VDC/220-240VAC	3°/8°
6x3W	OSRAM/CREE	Single	IK05	1080lm	12/24 VDC/220-240VAC	15°/25°/40°/60°/10°/60°/20°/55°
1x18W	CREE COB	Single	IK05	1520lm	24 VDC/220-240VAC	18°/24°/38°/60°
6x2.5W	OSRAM	RGB 3in 1	IK05	380lm	12/24 VDC/220-240VAC	25°/40°/60°
6x3.5W	OSRAM	RGBW 4in 1	IK05	520lm	12/24 VDC/220-240VAC	25°/40°/60°

## 3170R1\*a-XX-M2

Power	LED	CCT	IK	Luminous	Input Voltage	Beam Angle
6x4W	CREE	Single	IK05	1340lm	12/24 VDC/220-240VAC	3°/8°
12x3W	OSRAM/CREE	Single	IK05	2450lm	12/24 VDC/220-240VAC	15°/25°/40°/60°/10°/60°/20°/55°
1x35W	CREE COB	Single	IK05	3400lm	24 VDC/220-240VAC	18°/24°/38°/60°
12x2.5W	OSRAM	RGB 3in 1	IK05	600lm	12/24 VDC/220-240VAC	25°/40°/60°
12x3.5W	OSRAM	RGBW 4in 1	IK05	840lm	12/24 VDC/220-240VAC	25°/40°/60°

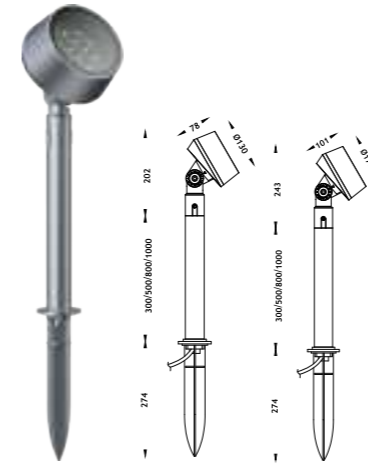

## 3130R1\*a-XX-B2

Power	LED	CCT	IK	Luminous	Input Voltage	Beam Angle
3x4W	CREE	Single	IK05	700lm	12/24 VDC/220-240VAC	3°/8°
6x3W	OSRAM/CREE	Single	IK05	1080lm	12/24 VDC/220-240VAC	15°/25°/40°/60°/10°/60°/20°/55°
1x18W	CREE COB	Single	IK05	1520lm	24 VDC/220-240VAC	18°/24°/38°/60°
6x2.5W	OSRAM	RGB 3in 1	IK05	380lm	12/24 VDC/220-240VAC	25°/40°/60°
6x3.5W	OSRAM	RGBW 4in 1	IK05	520lm	12/24 VDC/220-240VAC	25°/40°/60°

## 3170R1\*a-XX-B2

Power	LED	CCT	IK	Luminous	Input Voltage	Beam Angle
6x4W	CREE	Single	IK05	1340lm	12/24 VDC/220-240VAC	3°/8°
12x3W	OSRAM/CREE	Single	IK05	2450lm	12/24 VDC/220-240VAC	15°/25°/40°/60°/10°/60°/20°/55°
1x35W	CREE COB	Single	IK05	3400lm	24 VDC/220-240VAC	18°/24°/38°/60°
12x2.5W	OSRAM	RGB 3in 1	IK05	600lm	12/24 VDC/220-240VAC	25°/40°/60°
12x3.5W	OSRAM	RGBW 4in 1	IK05	840lm	12/24 VDC/220-240VAC	25°/40°/60°

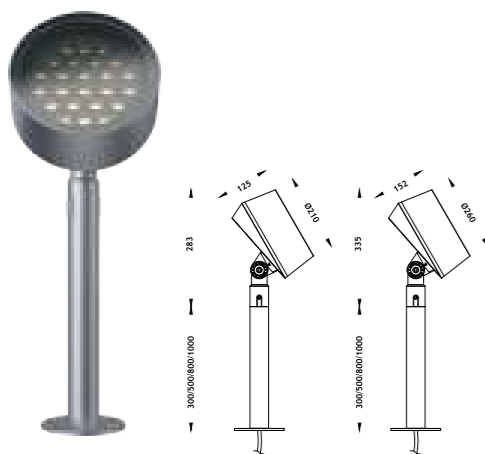

## 3210R1\*a-XX-M2

Power	LED	CCT	IK	Luminous	Input Voltage	Beam Angle
12x4W	CREE	Single	IK05	2400lm	12/24 VDC/220-240VAC	3°/8°
24x2W	OSRAM/CREE	Single	IK05	3750lm	12/24 VDC/220-240VAC	15°/25°/40°/60°/10°/60°/20°/55°
4x14W	CREE COB	Single	IK05	4950lm	24 VDC/220-240VAC	18°/24°/38°/60°
24x2.5W	OSRAM	RGB 3in 1	IK05	1500lm	12/24 VDC/220-240VAC	25°/40°/60°
24x3.5W	OSRAM	RGBW 4in 1	IK05	2000lm	12/24 VDC/220-240VAC	25°/40°/60°

## 3260R1\*a-XX-M2

Power	LED	CCT	IK	Luminous	Input Voltage	Beam Angle
18x4W	CREE	Single	IK05	4500lm	12/24 VDC/220-240VAC	3°/8°
36x2W	OSRAM/CREE	Single	IK05	4900lm	12/24 VDC/220-240VAC	15°/25°/40°/60°/10°/60°/20°/55°
4x18W	CREE COB	Single	IK05	6400lm	24 VDC/220-240VAC	18°/24°/38°/60°
36x3W	OSRAM	RGB 3in 1	IK05	2700lm	12/24 VDC/220-240VAC	25°/40°/60°
36x4W	OSRAM	RGBW 4in 1	IK05	3420lm	12/24 VDC/220-240VAC	25°/40°/60°

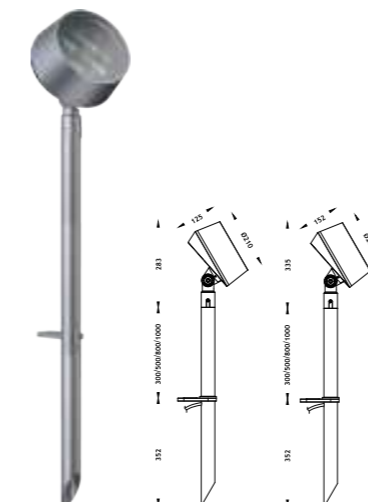

## 3210R1\*a-XX-B2

Power	LED	CCT	IK	Luminous	Input Voltage	Beam Angle
12x4W	CREE	Single	IK05	2400lm	12/24 VDC/220-240VAC	3°/8°
24x2W	OSRAM/CREE	Single	IK05	3750lm	12/24 VDC/220-240VAC	15°/25°/40°/60°/10°/60°/20°/55°
4x14W	CREE COB	Single	IK05	4950lm	24 VDC/220-240VAC	18°/24°/38°/60°
24x2.5W	OSRAM	RGB 3in 1	IK05	1500lm	12/24 VDC/220-240VAC	25°/40°/60°
24x3.5W	OSRAM	RGBW 4in 1	IK05	2000lm	12/24 VDC/220-240VAC	25°/40°/60°

## 3260R1\*a-XX-B2

Power	LED	CCT	IK	Luminous	Input Voltage	Beam Angle
18x4W	CREE	Single	IK05	4500lm	12/24 VDC/220-240VAC	3°/8°
36x2W	OSRAM/CREE	Single	IK05	4900lm	12/24 VDC/220-240VAC	15°/25°/40°/60°/10°/60°/20°/55°
4x18W	CREE COB	Single	IK05	6400lm	24 VDC/220-240VAC	18°/24°/38°/60°
36x3W	OSRAM	RGB 3in 1	IK05	2700lm	12/24 VDC/220-240VAC	25°/40°/60°
36x4W	OSRAM	RGBW 4in 1	IK05	3420lm	12/24 VDC/220-240VAC	25°/40°/60°



LED Landscape Spot Light  
-- Series LS

< Bind the Pair

## LED Landscape Spot Light -- Series LS



### 3170S1\*a-XX-M

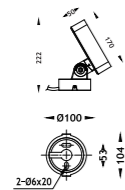

Power	LED	CCT	IK	Luminous	Input Voltage	Beam Angle
6x4W	CREE	Single	IK05	1320lm	12/24 VDC/220-240VAC	3°/8°
12x2W	OSRAM/CREE	Single	IK05	1920lm	12/24 VDC/220-240VAC	15°/25°/40°/60°/10°60°/20°55°
2x12W	CREE COB	Single	IK05	2400lm	24 VDC/220-240VAC	18°/24°/38°/60°
12x2.5W	OSRAM	RGB 3in 1	IK05	1160lm	12/24 VDC/220-240VAC	25°/40°/60°
12x3.5W	OSRAM	RGBW 4in 1	IK05	1400lm	12/24 VDC/220-240VAC	25°/40°/60°



### 3170S1\*a-XX-B

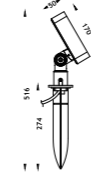

Power	LED	CCT	IK	Luminous	Input Voltage	Beam Angle
6x4W	CREE	Single	IK05	1320lm	12/24 VDC/220-240VAC	3°/8°
12x2W	OSRAM/CREE	Single	IK05	1920lm	12/24 VDC/220-240VAC	15°/25°/40°/60°/10°60°/20°55°
2x12W	CREE COB	Single	IK05	2400lm	24 VDC/220-240VAC	18°/24°/38°/60°
12x2.5W	OSRAM	RGB 3in 1	IK05	1160lm	12/24 VDC/220-240VAC	25°/40°/60°
12x3.5W	OSRAM	RGBW 4in 1	IK05	1400lm	12/24 VDC/220-240VAC	25°/40°/60°

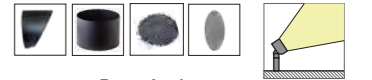

### 3210S1\*a-XX-M

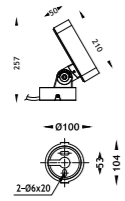

Power	LED	CCT	IK	Luminous	Input Voltage	Beam Angle
12x3.5W	CREE	Single	IK05	2400lm	12/24 VDC/220-240VAC	3°/8°
24x2W	OSRAM/CREE	Single	IK05	3200lm	12/24 VDC/220-240VAC	15°/25°/40°/60°/10°60°/20°55°
4x10W	CREE COB	Single	IK05	3600lm	24 VDC/220-240VAC	18°/24°/38°/60°
24x2.5W	OSRAM	RGB 3in 1	IK05	2280lm	12/24 VDC/220-240VAC	25°/40°/60°
24x3W	OSRAM	RGBW 4in 1	IK05	2700lm	12/24 VDC/220-240VAC	25°/40°/60°

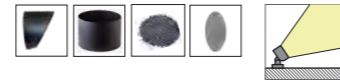

### 3210S1\*a-XX-B

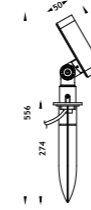

Power	LED	CCT	IK	Luminous	Input Voltage	Beam Angle
12x3.5W	CREE	Single	IK05	2400lm	12/24 VDC/220-240VAC	3°/8°
24x2W	OSRAM/CREE	Single	IK05	3200lm	12/24 VDC/220-240VAC	15°/25°/40°/60°/10°60°/20°55°
4x10W	CREE COB	Single	IK05	3600lm	24 VDC/220-240VAC	18°/24°/38°/60°
24x2.5W	OSRAM	RGB 3in 1	IK05	2280lm	12/24 VDC/220-240VAC	25°/40°/60°
24x3W	OSRAM	RGBW 4in 1	IK05	2700lm	12/24 VDC/220-240VAC	25°/40°/60°

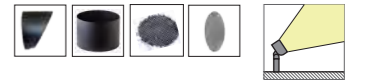

### 3260S1\*a-XX-M

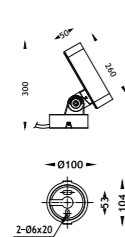

Power	LED	CCT	IK	Luminous	Input Voltage	Beam Angle
18x3W	CREE	Single	IK05	1320lm	12/24 VDC/220-240VAC	3°/8°
36x1.5W	OSRAM/CREE	Single	IK05	1920lm	12/24 VDC/220-240VAC	15°/25°/40°/60°/10°60°/20°55°
4x13W	CREE COB	Single	IK05	2400lm	24 VDC/220-240VAC	18°/24°/38°/60°
36x2W	OSRAM	RGB 3in 1	IK05	1160lm	12/24 VDC/220-240VAC	25°/40°/60°
36x3W	OSRAM	RGBW 4in 1	IK05	1400lm	12/24 VDC/220-240VAC	25°/40°/60°

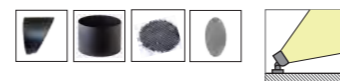

### 3260S1\*a-XX-B



Power	LED	CCT	IK	Luminous	Input Voltage	Beam Angle
18x3W	CREE	Single	IK05	1320lm	12/24 VDC/220-240VAC	3°/8°
36x1.5W	OSRAM/CREE	Single	IK05	1920lm	12/24 VDC/220-240VAC	15°/25°/40°/60°/10°60°/20°55°
4x13W	CREE COB	Single	IK05	2400lm	24 VDC/220-240VAC	18°/24°/38°/60°
36x2W	OSRAM	RGB 3in 1	IK05	1160lm	12/24 VDC/220-240VAC	25°/40°/60°
36x3W	OSRAM	RGBW 4in 1	IK05	1400lm	12/24 VDC/220-240VAC	25°/40°/60°

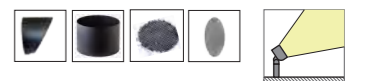

## LED Landscape Spot Light -- Series LS



### 3170S1\*a-XX-H

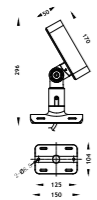
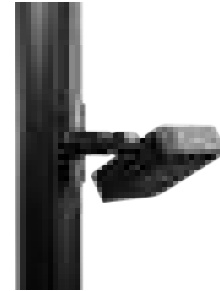

Power	LED	CCT	IK	Luminous	Input Voltage	Beam Angle
6x4W	CREE	Single	IK05	1320lm	12/24 VDC/220-240VAC	3°/8°
12x2W	OSRAM/CREE	Single	IK05	1920lm	12/24 VDC/220-240VAC	15°/25°/40°/60°/10°60°/20°55°
2x12W	CREE COB	Single	IK05	2400lm	24 VDC/220-240VAC	18°/24°/38°/60°
12x2.5W	OSRAM	RGB 3in 1	IK05	1160lm	12/24 VDC/220-240VAC	25°/40°/60°
12x3.5W	OSRAM	RGBW 4in 1	IK05	1400lm	12/24 VDC/220-240VAC	25°/40°/60°

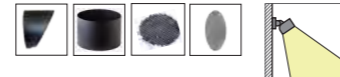

### 3170S1\*a-XX-H2

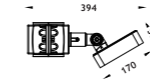

Power	LED	CCT	IK	Luminous	Input Voltage	Beam Angle
6x4W	CREE	Single	IK05	1320lm	12/24 VDC/220-240VAC	3°/8°
12x2W	OSRAM/CREE	Single	IK05	1920lm	12/24 VDC/220-240VAC	15°/25°/40°/60°/10°60°/20°55°
2x12W	CREE COB	Single	IK05	2400lm	24 VDC/220-240VAC	18°/24°/38°/60°
12x2.5W	OSRAM	RGB 3in 1	IK05	1160lm	12/24 VDC/220-240VAC	25°/40°/60°
12x3.5W	OSRAM	RGBW 4in 1	IK05	1400lm	12/24 VDC/220-240VAC	25°/40°/60°

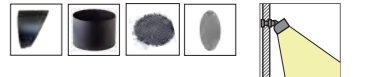

### 3210S1\*a-XX-H

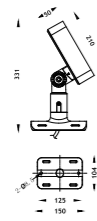
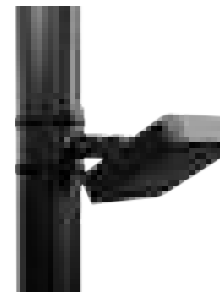

Power	LED	CCT	IK	Luminous	Input Voltage	Beam Angle
12x3.5W	CREE	Single	IK05	2400lm	12/24 VDC/220-240VAC	3°/8°
24x2W	OSRAM/CREE	Single	IK05	3200lm	12/24 VDC/220-240VAC	15°/25°/40°/60°/10°60°/20°55°
4x10W	CREE COB	Single	IK05	3600lm	24 VDC/220-240VAC	18°/24°/38°/60°
24x2.5W	OSRAM	RGB 3in 1	IK05	2280lm	12/24 VDC/220-240VAC	25°/40°/60°
24x3W	OSRAM	RGBW 4in 1	IK05	2700lm	12/24 VDC/220-240VAC	25°/40°/60°

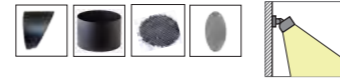

### 3210S1\*a-XX-H2

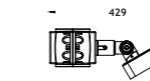

Power	LED	CCT	IK	Luminous	Input Voltage	Beam Angle
12x3.5W	CREE	Single	IK05	2400lm	12/24 VDC/220-240VAC	3°/8°
24x2W	OSRAM/CREE	Single	IK05	3200lm	12/24 VDC/220-240VAC	15°/25°/40°/60°/10°60°/20°55°
4x10W	CREE COB	Single	IK05	3600lm	24 VDC/220-240VAC	18°/24°/38°/60°
24x2.5W	OSRAM	RGB 3in 1	IK05	2280lm	12/24 VDC/220-240VAC	25°/40°/60°
24x3W	OSRAM	RGBW 4in 1	IK05	2700lm	12/24 VDC/220-240VAC	25°/40°/60°

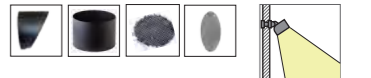

### 3260S1\*a-XX-H

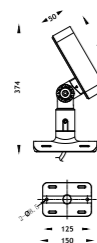
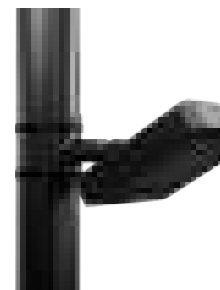

Power	LED	CCT	IK	Luminous	Input Voltage	Beam Angle
18x3W	CREE	Single	IK05	1320lm	12/24 VDC/220-240VAC	3°/8°
36x1.5W	OSRAM/CREE	Single	IK05	1920lm	12/24 VDC/220-240VAC	15°/25°/40°/60°/10°60°/20°55°
4x13W	CREE COB	Single	IK05	2400lm	24 VDC/220-240VAC	18°/24°/38°/60°
36x2W	OSRAM	RGB 3in 1	IK05	1160lm	12/24 VDC/220-240VAC	25°/40°/60°
36x3W	OSRAM	RGBW 4in 1	IK05	1400lm	12/24 VDC/220-240VAC	25°/40°/60°

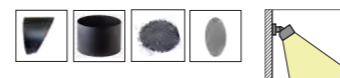

### 3260S1\*a-XX-H

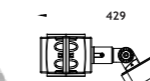

Power	LED	CCT	IK	Luminous	Input Voltage	Beam Angle
18x3W	CREE	Single	IK05	1320lm	12/24 VDC/220-240VAC	3°/8°
36x1.5W	OSRAM/CREE	Single	IK05	1920lm	12/24 VDC/220-240VAC	15°/25°/40°/60°/10°60°/20°55°
4x13W	CREE COB	Single	IK05	2400lm	24 VDC/220-240VAC	18°/24°/38°/60°
36x2W	OSRAM	RGB 3in 1	IK05	1160lm	12/24 VDC/220-240VAC	25°/40°/60°
36x3W	OSRAM	RGBW 4in 1	IK05	1400lm	12/24 VDC/220-240VAC	25°/40°/60°

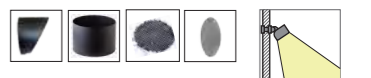

## LED Landscape Spot Light -- Series TW



### 3170S1\*a-XX-M2



Power	LED	CCT	IK	Luminous	Input Voltage	Beam Angle
6x4W	CREE	Single	IK05	1320lm	12/24 VDC/220-240VAC	3°/8°
12x2W	OSRAM/CREE	Single	IK05	1920lm	12/24 VDC/220-240VAC	15°/25°/40°/60°/10°60°/20°55°
2x12W	CREE COB	Single	IK05	2400lm	24 VDC/220-240VAC	18°/24°/38°/60°
12x2.5W	OSRAM	RGB 3in 1	IK05	1160lm	12/24 VDC/220-240VAC	25°/40°/60°
12x3.5W	OSRAM	RGBW 4in 1	IK05	1400lm	12/24 VDC/220-240VAC	25°/40°/60°

### 3210S1\*a-XX-M2

Power	LED	CCT	IK	Luminous	Input Voltage	Beam Angle
12x3.5W	CREE	Single	IK05	2400lm	12/24 VDC/220-240VAC	3°/8°
24x2W	OSRAM/CREE	Single	IK05	3200lm	12/24 VDC/220-240VAC	15°/25°/40°/60°/10°60°/20°55°
4x10W	CREE COB	Single	IK05	3600lm	24 VDC/220-240VAC	18°/24°/38°/60°
24x2.5W	OSRAM	RGB 3in 1	IK05	2280lm	12/24 VDC/220-240VAC	25°/40°/60°
24x3W	OSRAM	RGBW 4in 1	IK05	2700lm	12/24 VDC/220-240VAC	25°/40°/60°

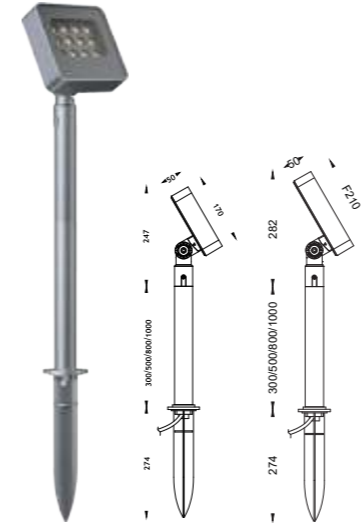

### 3170S1\*a-XX-B2



Power	LED	CCT	IK	Luminous	Input Voltage	Beam Angle
6x4W	CREE	Single	IK05	1320lm	12/24 VDC/220-240VAC	3°/8°
12x2W	OSRAM/CREE	Single	IK05	1920lm	12/24 VDC/220-240VAC	15°/25°/40°/60°/10°60°/20°55°
2x12W	CREE COB	Single	IK05	2400lm	24 VDC/220-240VAC	18°/24°/38°/60°
12x2.5W	OSRAM	RGB 3in 1	IK05	1160lm	12/24 VDC/220-240VAC	25°/40°/60°
12x3.5W	OSRAM	RGBW 4in 1	IK05	1400lm	12/24 VDC/220-240VAC	25°/40°/60°

### 3210S1\*a-XX-B2

Power	LED	CCT	IK	Luminous	Input Voltage	Beam Angle
12x3.5W	CREE	Single	IK05	2400lm	12/24 VDC/220-240VAC	3°/8°
24x2W	OSRAM/CREE	Single	IK05	3200lm	12/24 VDC/220-240VAC	15°/25°/40°/60°/10°60°/20°55°
4x10W	CREE COB	Single	IK05	3600lm	24 VDC/220-240VAC	18°/24°/38°/60°
24x2.5W	OSRAM	RGB 3in 1	IK05	2280lm	12/24 VDC/220-240VAC	25°/40°/60°
24x3W	OSRAM	RGBW 4in 1	IK05	2700lm	12/24 VDC/220-240VAC	25°/40°/60°



### 3260S1\*a-XX-M2



Power	LED	CCT	IK	Luminous	Input Voltage	Beam Angle
18x3W	CREE	Single	IK05	1320lm	12/24 VDC/220-240VAC	3°/8°
36x1.5W	OSRAM/CREE	Single	IK05	1920lm	12/24 VDC/220-240VAC	15°/25°/40°/60°/10°60°/20°55°
4x13W	CREE COB	Single	IK05	2400lm	24 VDC/220-240VAC	18°/24°/38°/60°
36x2W	OSRAM	RGB 3in 1	IK05	1160lm	12/24 VDC/220-240VAC	25°/40°/60°
36x3W	OSRAM	RGBW 4in 1	IK05	1400lm	12/24 VDC/220-240VAC	25°/40°/60°

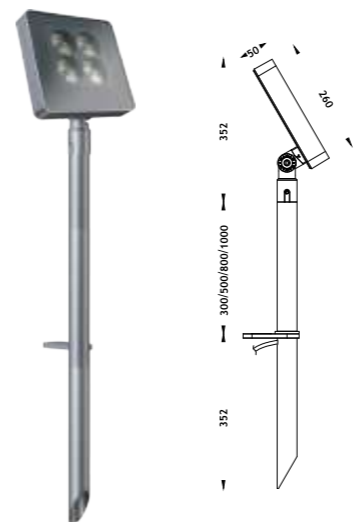

### 3260S1\*a-XX-B2



Power	LED	CCT	IK	Luminous	Input Voltage	Beam Angle
18x3W	CREE	Single	IK05	1320lm	12/24 VDC/220-240VAC	3°/8°
36x1.5W	OSRAM/CREE	Single	IK05	1920lm	12/24 VDC/220-240VAC	15°/25°/40°/60°/10°60°/20°55°
4x13W	CREE COB	Single	IK05	2400lm	24 VDC/220-240VAC	18°/24°/38°/60°
36x2W	OSRAM	RGB 3in 1	IK05	1160lm	12/24 VDC/220-240VAC	25°/40°/60°
36x3W	OSRAM	RGBW 4in 1	IK05	1400lm	12/24 VDC/220-240VAC	25°/40°/60°

## LED Landscape Spot Light

CE ErP IP65 RoHS 1-10V Triac PWM DALI DMX RGB RGBW

### 3115R1\*a-XX-X



Power	LED	CCT	IK	Luminous	Input Voltage	Beam Angle
3x2W	OSRAM/CREE	Single	IK08	400lm	12/24 VDC/220-240VAC	12°/25°/40°/60°
1x6W	CREE COB	Single	IK08	480lm	12/24 VDC/220-240VAC	18°/24°/38°/60°

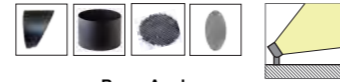

### 3075R1\*c-B4-M



Power	LED	CCT	IK	Luminous	Input Voltage	Beam Angle
1x13W	CREE	Single	IK04	1040lm	12/24 VDC/220-240VAC	18°/24°/38°/60°

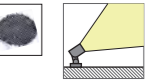

### 3115R3\*a-XX-X



Power	LED	CCT	IK	Luminous	Input Voltage	Beam Angle
3x2W	OSRAM/CREE	Single	IK08	400lm	12/24 VDC/220-240VAC	12°/25°/40°/60°
1x6W	CREE COB	Single	IK08	480lm	12/24 VDC/220-240VAC	18°/24°/38°/60°

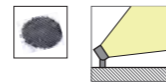

### 3075R3\*c-B4-B



Power	LED	CCT	IK	Luminous	Input Voltage	Beam Angle
1x13W	CREE	Single	IK04	1040lm	12/24 VDC/220-240VAC	18°/24°/38°/60°

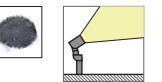

### 3173R1\*a-XX-X



Power	LED	CCT	IK	Luminous	Input Voltage	Beam Angle
6x2W	OSRAM/CREE	Single	IK09	840lm	12/24 VDC/220-240VAC	12°/25°/40°/60°
1x12W	CREE COB	Single	IK09	960lm	12/24 VDC/220-240VAC	18°/24°/38°/60°
9x1.5W	OSRAM	Single	IK09	870lm	12/24 VDC/220-240VAC	25°/40°/60°

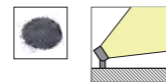

### 3173R3\*a-XX-X



Power	LED	CCT	IK	Luminous	Input Voltage	Beam Angle
6x2W	OSRAM/CREE	Single	IK09	840lm	12/24 VDC/220-240VAC	12°/25°/40°/60°
1x12W	CREE COB	Single	IK09	960lm	12/24 VDC/220-240VAC	18°/24°/38°/60°
9x1.5W	OSRAM	Single	IK09	870lm	12/24 VDC/220-240VAC	25°/40°/60°

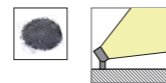

# LED Landscape Spot Light



## 3102R1\*a-XX-M

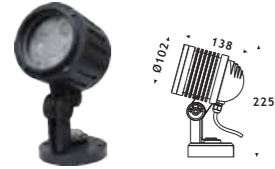

Power	LED	CCT	IK	Luminous	Input Voltage	Beam Angle
6x2W	OSRAM/CREE	Single	IK04	780lm	12/24 VDC/220-240VAC	8°/15°/25°/40°/60°
1x12W	CREE COB	Single	IK04	960lm	12/24 VDC/220-240VAC	25°/40°/60°
5x3W	OSRAM	RGB 3in1	IK04	300lm	12/24 VDC	25°/40°/60°

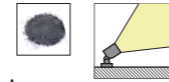

## 3102R1\*a-XX-B



Power	LED	CCT	IK	Luminous	Input Voltage	Beam Angle
6x2W	OSRAM/CREE	Single	IK04	780lm	12/24 VDC/220-240VAC	8°/15°/25°/40°/60°
1x12W	CREE COB	Single	IK04	960lm	12/24 VDC/220-240VAC	25°/40°/60°
5x3W	OSRAM	RGB 3in1	IK04	300lm	12/24 VDC	25°/40°/60°

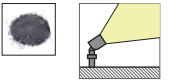

## 3102R3\*a-XX-M

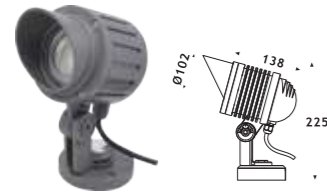

Power	LED	CCT	IK	Luminous	Input Voltage	Beam Angle
6x2W	OSRAM/CREE	Single	IK04	780lm	12/24 VDC/220-240VAC	8°/15°/25°/40°/60°
1x12W	CREE COB	Single	IK04	960lm	12/24 VDC/220-240VAC	25°/40°/60°
5x3W	OSRAM	RGB 3in1	IK04	300lm	12/24 VDC	25°/40°/60°

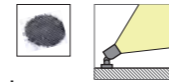

## 3102R3\*a-XX-B



Power	LED	CCT	IK	Luminous	Input Voltage	Beam Angle
6x2W	OSRAM/CREE	Single	IK04	780lm	12/24 VDC/220-240VAC	8°/15°/25°/40°/60°
1x12W	CREE COB	Single	IK04	960lm	12/24 VDC/220-240VAC	25°/40°/60°
5x3W	OSRAM	RGB 3in1	IK04	300lm	12/24 VDC	25°/40°/60°

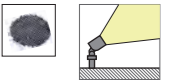

## 3100R1\*c-XX-M

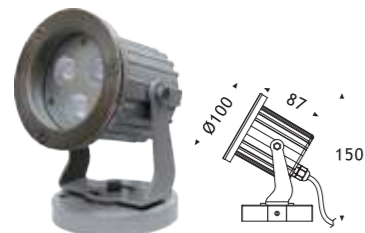

Power	LED	CCT	IK	Luminous	Input Voltage	Beam Angle
3x2W	OSRAM/CREE	Single	IK04	390lm	12/24 VDC/220-240VAC	15°/25°/40°
1x6W	CREE COB	Single	IK04	480lm	12/24 VDC/220-240VAC	25°/40°/60°

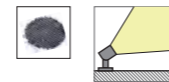

## 3100R1\*c-XX-B



Power	LED	CCT	IK	Luminous	Input Voltage	Beam Angle
3x2W	OSRAM/CREE	Single	IK04	390lm	12/24 VDC/220-240VAC	15°/25°/40°
1x6W	CREE COB	Single	IK04	480lm	12/24 VDC/220-240VAC	25°/40°/60°

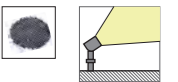

## LED Wall Light

Led Wall luminaires stands out for special housing design and high quality optical components specifically for demanding visual tasks to provide enhanced visual comfort.

Housing made of 12# Die-casting aluminum with Akzo powder coated. Clear tempered safety glass, transmittance efficiency is over 95% and the accuracy of color temperature as well as strong impact resistance bearing capacity.



One-way >



## LED Wall Light

Quick & simple installation with low maintenance. Sturdy construction in order to maintain performance of the luminaire and to reduce maintenance costs. Applicable for outdoor installation, hotel,vila,facade, residential.

### LED Wall Light

Website: [WWW.iliteuk.com](http://WWW.iliteuk.com)

Email: [sales@iliteuk.com](mailto:sales@iliteuk.com)

Address: 1 Hatton Street, London, United Kingdom, NW8 8PL



LED Wall Light

Website: [WWW.iliteuk.com](http://WWW.iliteuk.com)

Email: [sales@iliteuk.com](mailto:sales@iliteuk.com)

Address: 1 Hatton Street, London, United Kingdom, NW8 8PL



**Specialized in LED Outdoor Light**

Sturdy construction in order to maintain performance of the luminaire and to reduce maintenance costs.

Applicable for outdoor installation, hotel, villa, facade, residential. Quick & simple installation with low maintenance.

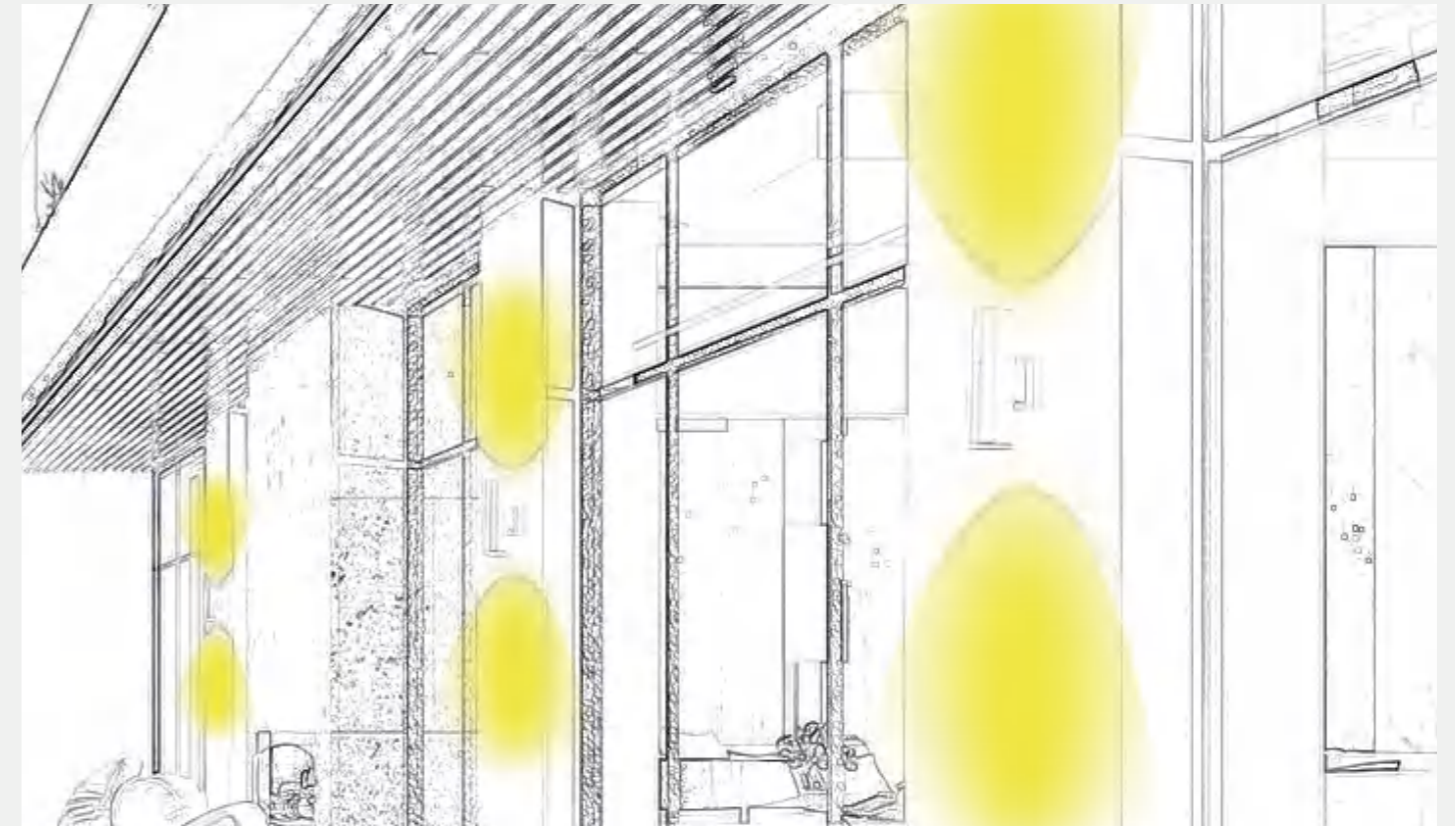

**Material Quality**

12# Die-casting powder coated aluminum housing  
Tempered glass.

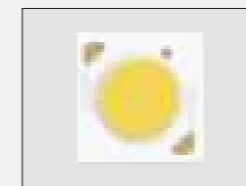

**LED**

CREE/OSRAM/BRIDGELUX, CRI>80(CRI>90 on request)  
Cable 0.5m



**Quality/Supporting**

IP65 IK08  
Life time ≥50000 hrs  
Operating temperature -20 C ~40 C



LED Wall Light

Website: [WWW.iliteuk.com](http://WWW.iliteuk.com)

Email: [sales@iliteuk.com](mailto:sales@iliteuk.com)

Address: 1 Hatton Street, London, United Kingdom, NW8 8PL



## LED Wall Light



### 1050R1\*a-B3-X

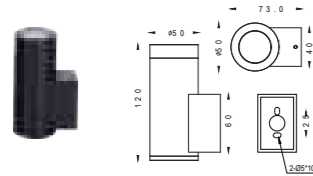

Color	Power	LED	CCT	IK	Luminous	Input Voltage	Beam Angle
White	1x5W	CREE COB	Single	IK05	408lm	12/24 VDC/220-240VAC	10°
Black	1x5W	CREE COB	Single	IK05	408lm	12/24 VDC/220-240VAC	18°/22°/31°/58°
Customized							



### 1050R1\*b-B3-X

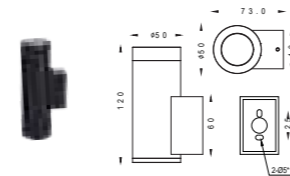

Color	Power	LED	CCT	IK	Luminous	Input Voltage	Beam Angle
White	2x4W	CREE COB	Single	IK05	2*408lm	12/24 VDC/220-240VAC	10°
Black	2x4W	CREE COB	Single	IK05	2*408lm	12/24 VDC/220-240VAC	18°/22°/31°/58°
Customized							



### 1060R1\*a-B3-X

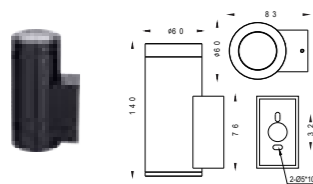

Color	Power	LED	CCT	IK	Luminous	Input Voltage	Beam Angle
White	1x10W	CREE COB	Single	IK05	1180lm	12/24 VDC/220-240VAC	10°
Black	1x10W	CREE COB	Single	IK05	1180lm	12/24 VDC/220-240VAC	18°/22°/31°/58°
Customized							



### 1060R1\*b-B3-X

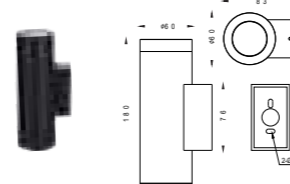

Color	Power	LED	CCT	IK	Luminous	Input Voltage	Beam Angle
White	2x8W	CREE COB	Single	IK05	2*837lm	12/24 VDC/220-240VAC	10°
Black	2x8W	CREE COB	Single	IK05	2*837lm	12/24 VDC/220-240VAC	18°/22°/31°/58°
Customized							



### 1075R1\*a-B3-X

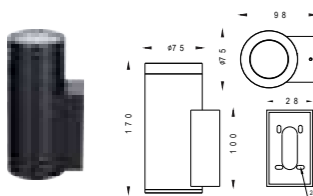

Color	Power	LED	CCT	IK	Luminous	Input Voltage	Beam Angle
White	1x15W	CREE COB	Single	IK05	1412lm	12/24 VDC/220-240VAC	10°
Black	1x15W	CREE COB	Single	IK05	1412lm	12/24 VDC/220-240VAC	18°/22°/31°/58°
Customized							



### 1075R1\*b-B3-X

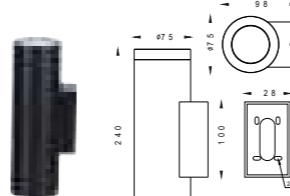

Color	Power	LED	CCT	IK	Luminous	Input Voltage	Beam Angle
White	2x13W	CREE COB	Single	IK05	2*1082lm	12/24 VDC/220-240VAC	3°/8°
Black	2x13W	CREE COB	Single	IK05	2*1082lm	12/24 VDC/220-240VAC	18°/22°/31°/58°
Customized							



### 1100R1\*a-B3-X

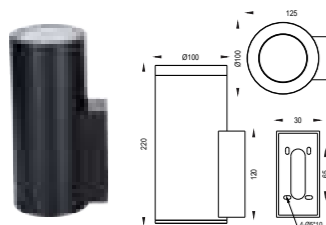

Color	Power	LED	CCT	IK	Luminous	Input Voltage	Beam Angle
White	1x20W	CREE COB	Single	IK05	2121lm	12/24 VDC/220-240VAC	10°
Black	1x20W	CREE COB	Single	IK05	2121lm	12/24 VDC/220-240VAC	18°/22°/31°/58°
Customized							



### 1100R1\*b-B3-X

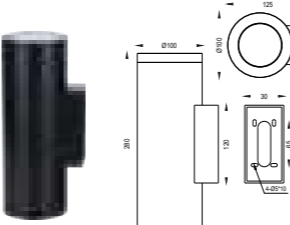

Color	Power	LED	CCT	IK	Luminous	Input Voltage	Beam Angle
White	2x18W	CREE COB	Single	IK05	2*1788lm	12/24 VDC/220-240VAC	10°
Black	2x18W	CREE COB	Single	IK05	2*1788lm	12/24 VDC/220-240VAC	18°/22°/31°/61°
Customized							



# LED Wall Light



## 1130R1\*a-B3-X

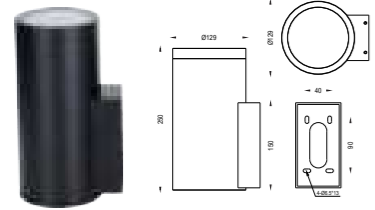

Color	Power	LED	CCT	IK	Luminous	Input Voltage	Beam Angle
White	1x35W	CREE COB	Single	IK05	2905lm	12/24 VDC/220-240VAC	10°
Black	1x35W	CREE COB	Single	IK05	2905lm	12/24 VDC/220-240VAC	18°/22°/30°/60°
Customized	6x4W	OSRAM SMD	RGB 3in 1	IK05	600lm	12/24 VDC	10°/20°/30°/60°
	6x4W	OSRAM SMD	RGBW 4in 1	IK05	600lm	12/24 VDC	10°/20°/30°/60°

## 1130R1\*b-B3-X

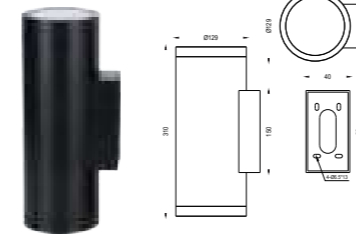

Color	Power	LED	CCT	IK	Luminous	Input Voltage	Beam Angle
White	2x35W	CREE COB	Single	IK05	2*2905lm	12/24 VDC/220-240VAC	10°
Black	2x35W	CREE COB	Single	IK05	2*2905lm	12/24 VDC/220-240VAC	18°/22°/30°/60°
Customized	2x(6x4W)	OSRAM SMD	RGB 3in 1	IK05	2*600lm	12/24 VDC	10°/20°/30°/60°
	2x(6x4W)	OSRAM SMD	RGBW 4in 1	IK05	2*600lm	12/24 VDC	10°/20°/30°/60°



LED Wall Light

Website: [WWW.iliteuk.com](http://WWW.iliteuk.com)

Email: [sales@iliteuk.com](mailto:sales@iliteuk.com)

Address: 1 Hatton Street, London, United Kingdom, NW8 8PL

# LED Wall Light



## 1050S1\*a-B3-X

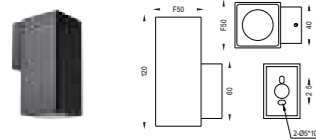

Color	Power	LED	CCT	IK	Luminous	Input Voltage	Beam Angle
White	1x5W	CREE COB	Single	IK05	408lm	12/24 VDC/220-240VAC	10°
Black	1x5W	CREE COB	Single	IK05	408lm	12/24 VDC/220-240VAC	18°/22°/30°/60°
Customized							



## 1050S1\*b-B3-X

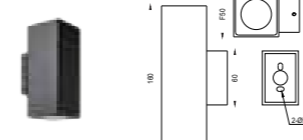

Color	Power	LED	CCT	IK	Luminous	Input Voltage	Beam Angle
White	2x4W	CREE COB	Single	IK05	2*408lm	12/24 VDC/220-240VAC	10°
Black	2x4W	CREE COB	Single	IK05	2*408lm	12/24 VDC/220-240VAC	18°/22°/30°/60°
Customized							



## 1060S1\*a-B3-X

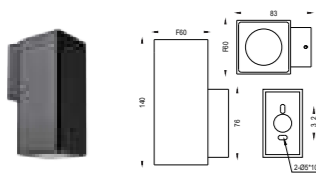

Color	Power	LED	CCT	IK	Luminous	Input Voltage	Beam Angle
White	1x10W	CREE COB	Single	IK05	1180lm	12/24 VDC/220-240VAC	10°
Black	1x10W	CREE COB	Single	IK05	1180lm	12/24 VDC/220-240VAC	18°/22°/30°/60°
Customized							



## 1060S1\*b-B3-X

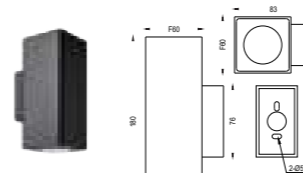

Color	Power	LED	CCT	IK	Luminous	Input Voltage	Beam Angle
White	2x8W	CREE COB	Single	IK05	2*837lm	12/24 VDC/220-240VAC	10°
Black	2x8W	CREE COB	Single	IK05	2*837lm	12/24 VDC/220-240VAC	18°/22°/30°/60°
Customized							



## 1075S1\*a-B3-X

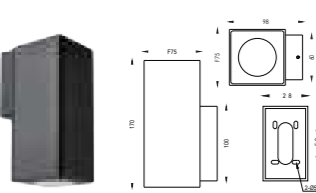

Color	Power	LED	CCT	IK	Luminous	Input Voltage	Beam Angle
White	1x15W	CREE COB	Single	IK05	1412lm	12/24 VDC/220-240VAC	10°
Black	1x15W	CREE COB	Single	IK05	1412lm	12/24 VDC/220-240VAC	18°/22°/30°/60°
Customized							



## 1075S1\*b-B3-X

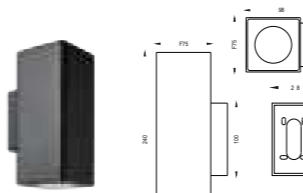

Color	Power	LED	CCT	IK	Luminous	Input Voltage	Beam Angle
White	2x13W	CREE COB	Single	IK05	2*1082lm	12/24 VDC/220-240VAC	3°/8°
Black	2x13W	CREE COB	Single	IK05	2*1082lm	12/24 VDC/220-240VAC	18°/22°/30°/60°
Customized							



## 1100S1\*a-B3-X

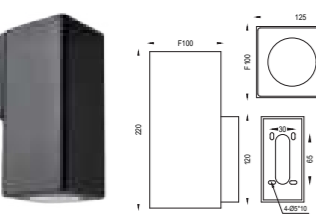

Color	Power	LED	CCT	IK	Luminous	Input Voltage	Beam Angle
White	1x20W	CREE COB	Single	IK05	2121lm	12/24 VDC/220-240VAC	10°
Black	1x20W	CREE COB	Single	IK05	2121lm	12/24 VDC/220-240VAC	18°/22°/30°/60°
Customized							



## 1100S1\*b-B3-X

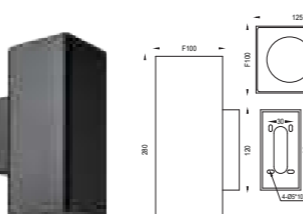

Color	Power	LED	CCT	IK	Luminous	Input Voltage	Beam Angle
White	2x18W	CREE COB	Single	IK05	2*1788lm	12/24 VDC/220-240VAC	10°
Black	2x18W	CREE COB	Single	IK05	2*1788lm	12/24 VDC/220-240VAC	18°/22°/30°/60°
Customized							



## LED Step Light

### 1063L2\*a-A3-Y-0.195M

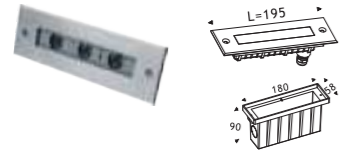

Power	LED	CCT	IK	Luminous	Input Voltage	Beam Angle
3X2W	CREE/OSRAM	Single	IK08	400lm	12/24 VDC/220-240VAC	10°/25°/40°/60°/45°/35°
3X2.5W	CREE/OSRAM	RGB 3in 1	IK08	180lm	12/24 VDC	25°/40°/60°/45°/35°
3X3.5W	CREE/OSRAM	RGBW 4in 1	IK08	260lm	12/24 VDC	25°/40°/60°/45°/35°

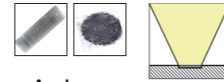

### 1063L2\*a-A3-Y-0.328M

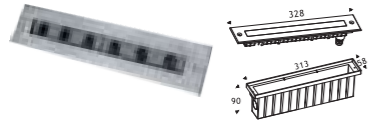

Power	LED	CCT	IK	Luminous	Input Voltage	Beam Angle
6x2W	CREE/OSRAM	Single	IK08	798lm	12/24 VDC/220-240VAC	10°/25°/40°/60°/45°/35°
6x2.5W	CREE/OSRAM	RGB 3in 1	IK08	375lm	12/24 VDC	25°/40°/60°/45°/35°
6x3.5W	CREE/OSRAM	RGBW 4in 1	IK08	520lm	12/24 VDC	25°/40°/60°/45°/35°

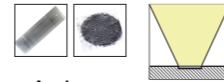

### 1063L4\*a-C7-Y-0.195M



Power	LED	CCT	IK	Luminous	Input Voltage	Beam Angle
2.2W	OSRAM	Single	IK08	25lm	12/24 VDC/220-240VAC	120°
2.2W	OSRAM	RGB 3in 1	IK08	25lm	12/24 VDC	120°

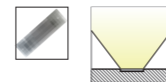

### 1063L4\*a-C7-Y-0.328M



Power	LED	CCT	IK	Luminous	Input Voltage	Beam Angle
4.8W	CREE/OSRAM	Single	IK08	50lm	12/24 VDC/220-240VAC	120°
4.8W	CREE/OSRAM	RGB 3in 1	IK08	25lm	12/24 VDC	120°

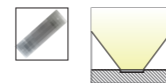

## LED Recessed Step Light

CE ErP IP65 RoHS 1-10V Triac PWM DALI RGB RGBW

CE ErP IP65 RoHS 1-10V Triac PWM DALI RGB RGBW

### 1171L5\*α-C7-Y

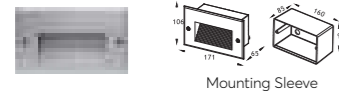

Color	Power	LED	CCT	IK	Luminous	Input Voltage	Beam Angle
White	2.4W	OSRAM	Single	IK05	47lm	12/24 VDC/220-240VAC	120°
Black	6W	OSRAM	Single	IK05	132lm	12/24 VDC/220-240VAC	120°
Silver							
Customized							



### 1045L5\*α-C7-Y



Power	LED	CCT	IK	Luminous	Input Voltage	Beam Angle
1.2W	OSRAM	Single	IK05	40lm	12/24 VDC/220-240VAC	120°



### 1106S5\*α-C7-Y

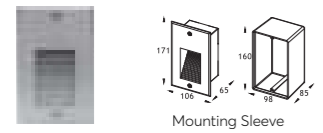

Color	Power	LED	CCT	IK	Luminous	Input Voltage	Beam Angle
White	1.4W	OSRAM	Single	IK05	35lm	12/24 VDC/220-240VAC	120°
Black	3W	OSRAM	Single	IK05	55lm	12/24 VDC/220-240VAC	120°
Silver							
Customized							



### 1095R5\*α-C7-Y



Power	LED	CCT	IK	Luminous	Input Voltage	Beam Angle
1.2W	OSRAM	Single	IK05	40lm	12/24 VDC/220-240VAC	120°



### 1120S5\*α-C7-Y

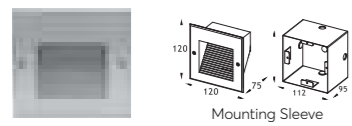

Color	Power	LED	CCT	IK	Luminous	Input Voltage	Beam Angle
White	1.6W	OSRAM	Single	IK05	35lm	12/24 VDC/220-240VAC	120°
Black	3W	OSRAM	Single	IK05	132lm	12/24 VDC/220-240VAC	120°
Silver							
Customized							



### WB1095S5\*α-C7-Y

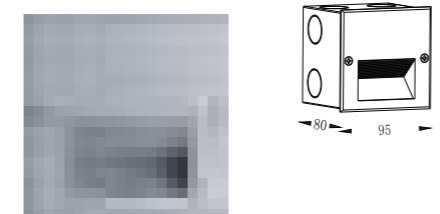

Power	LED	CCT	IK	Luminous	Input Voltage	Beam Angle
1.4W	OSRAM	Single	IK05	40lm	12/24 VDC/220-240VAC	120°



### 1160S5\*α-C7-Y

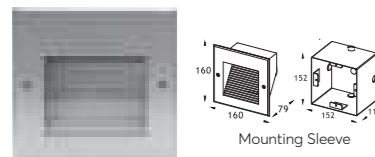

Color	Power	LED	CCT	IK	Luminous	Input Voltage	Beam Angle
White	3W	OSRAM	Single	IK05	75lm	12/24 VDC/220-240VAC	120°
Black	6W	OSRAM	Single	IK05	220lm	12/24 VDC/220-240VAC	120°
Silver							
Customized							



## LED Recessed Step Light



### 1078R5\*a-A3-Y

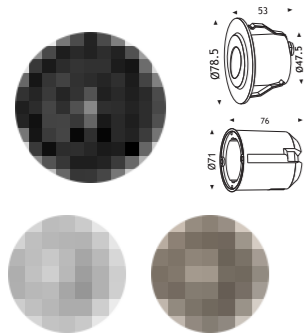

Color	Power	LED	CCT	IK	Luminous	Input Voltage	Beam Angle
White	1x2W	CREE	Single	IK05	60lm	12/24 VDC/220-240VAC	80°
Black							
Golden							



### 1078S5\*a-A3-Y

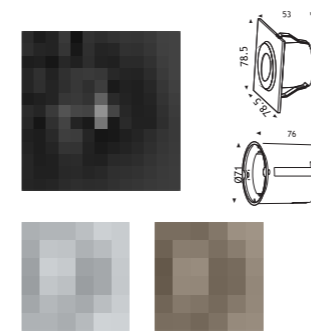

Color	Power	LED	CCT	IK	Luminous	Input Voltage	Beam Angle
White	1x2W	CREE	Single	IK05	60lm	12/24 VDC/220-240VAC	80°
Black							
Golden							



### 1078R5\*b-A3-Y

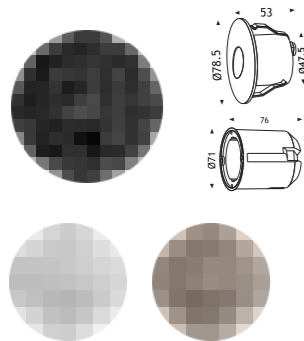

Color	Power	LED	CCT	IK	Luminous	Input Voltage	Beam Angle
White	1x2W	CREE	Single	IK05	60lm	12/24 VDC/220-240VAC	80°
Black							
Golden							



### 1078S5\*b-A3-Y

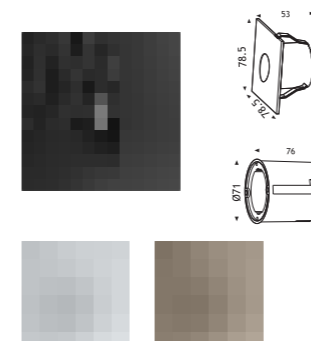

Color	Power	LED	CCT	IK	Luminous	Input Voltage	Beam Angle
White	1x2W	CREE	Single	IK05	60lm	12/24 VDC/220-240VAC	80°
Black							
Golden							



BLACK



WHITE



GOLDEN



## LED Window Light



### 1062R1\*-A3-X

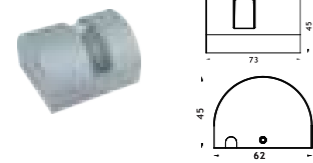

Color	Power	LED	CCT	IK	Luminous	Input Voltage	Beam Angle
White	1x3W	OSRAM/CREE	Single	IK05	171lm	12/24 VDC/220-240VAC	3°/180°
Black	3x2W	OSRAM/CREE	Single	IK05	321lm	12/24 VDC/220-240VAC	3°/180°
Customized							



### 1060S1\*A3-X-2WAY

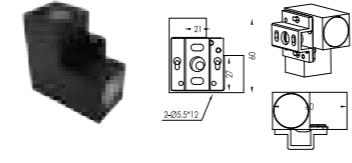

Color	Power	LED	CCT	IK	Luminous	Input Voltage	Beam Angle
White	2x2W	OSRAM	Single	IK05	280lm	12/24 VDC/220-240VAC	15°/25°
Black							
Customized							



### 1130R1\*α-A3-X

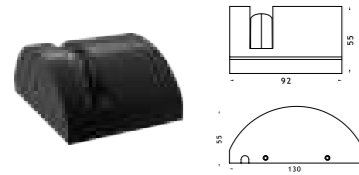

Color	Power	LED	CCT	IK	Luminous	Input Voltage	Beam Angle
White	6x2W	OSRAM	Single	IK05	660lm	12/24 VDC/220-240VAC	3°/180°
Black							
Customized							



### 1090S1\*A3-X-3WAY

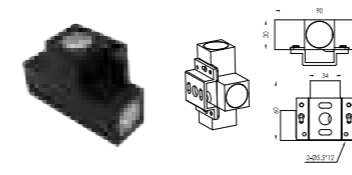

Color	Power	LED	CCT	IK	Luminous	Input Voltage	Beam Angle
White	3x2W	OSRAM	Single	IK05	400lm	12/24 VDC/220-240VAC	15°/25°
Black							
Customized							

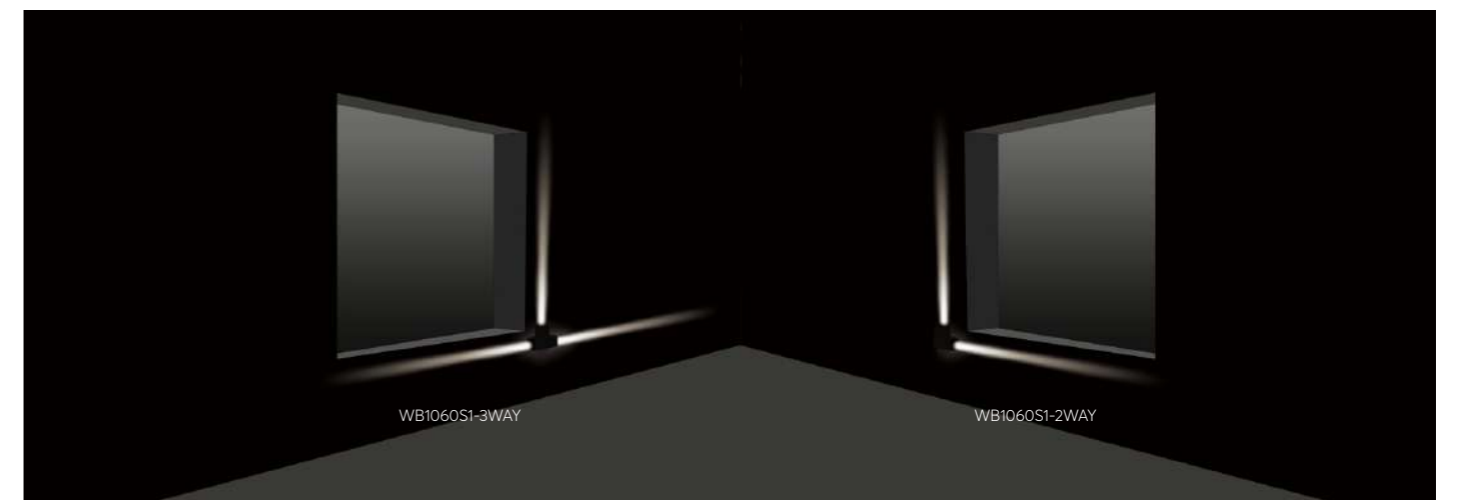

# LED Handrail Light

CE ERP IP67 RoHS 1-10V Triac PWM DALI DALI2

## 1030R1\*α-A3-X

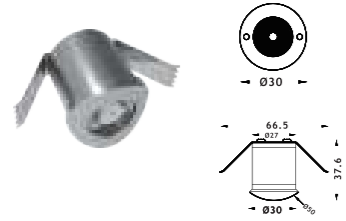

Color	Power	LED	CCT	IK	Luminous	Input Voltage	Beam Angle
Silver	1x1.5W	CREE/OSRAM	Single	IK05	120lm	12/24 VDC	15°/30°/40°/60°/90°
Customized	1x1.5W	CREE/OSRAM	Single	IK05	120lm	12/24 VDC	Asymmetric

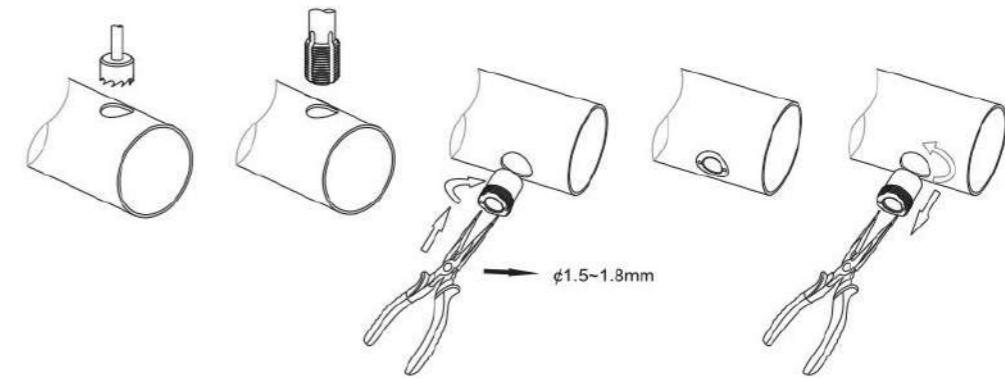
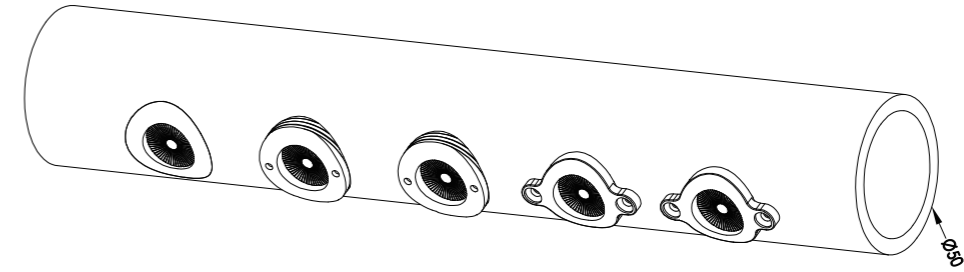
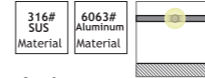

## 1030R1\*α-A3-X

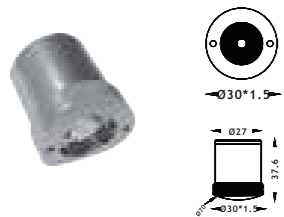

Color	Power	LED	CCT	IK	Luminous	Input Voltage	Beam Angle
Silver	1x1.5W	CREE/OSRAM	Single	IK05	120lm	12/24 VDC	15°/30°/40°/60°/90°
Customized	1x1.5W	CREE/OSRAM	Single	IK05	120lm	12/24 VDC	Asymmetric



## 1041R1\*α-A3-X

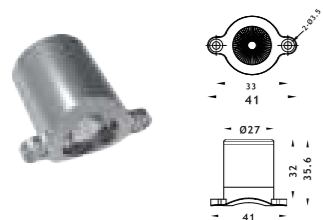

Color	Power	LED	CCT	IK	Luminous	Input Voltage	Beam Angle
Silver	1x1.5W	CREE/OSRAM	Single	IK05	120lm	12/24 VDC	15°/30°/40°/60°/90°
Customized	1x1.5W	CREE/OSRAM	Single	IK05	120lm	12/24 VDC	Asymmetric



## Series UR

Housing of underwater light is made of SUS 316L stainless steel, with structure water-proof design and filled with sealing glue for double water proof, reaching IP68 waterproof rate.

Recessed and Surface mounted version is available in different CCT options including RGB, creating special lighting effects.



## Series UR

High efficiency LED underwater luminaire for illumination of medium and large swimming pools, water features and fountains, revealing underwater architecture.



< CREE COB

< IK08/IP68

LED Underwater Light

Website: [WWW.iliteuk.com](http://WWW.iliteuk.com)

Email: [sales@iliteuk.com](mailto:sales@iliteuk.com)

Address: 1 Hatton Street, London, United Kingdom, NW8 8PL



LED Underwater Light

Website: [WWW.iliteuk.com](http://WWW.iliteuk.com)

Email: [sales@iliteuk.com](mailto:sales@iliteuk.com)

Address: 1 Hatton Street, London, United Kingdom, NW8 8PL



**Series UR**

High efficiency LED underwater luminaire for illumination of medium and large swimming pools, water features and fountains, revealing underwater architecture.

The Series UR uses anti-glare design, achieving URG less than 16. Clear tempered safety glass, transmittance of light is over 95%.

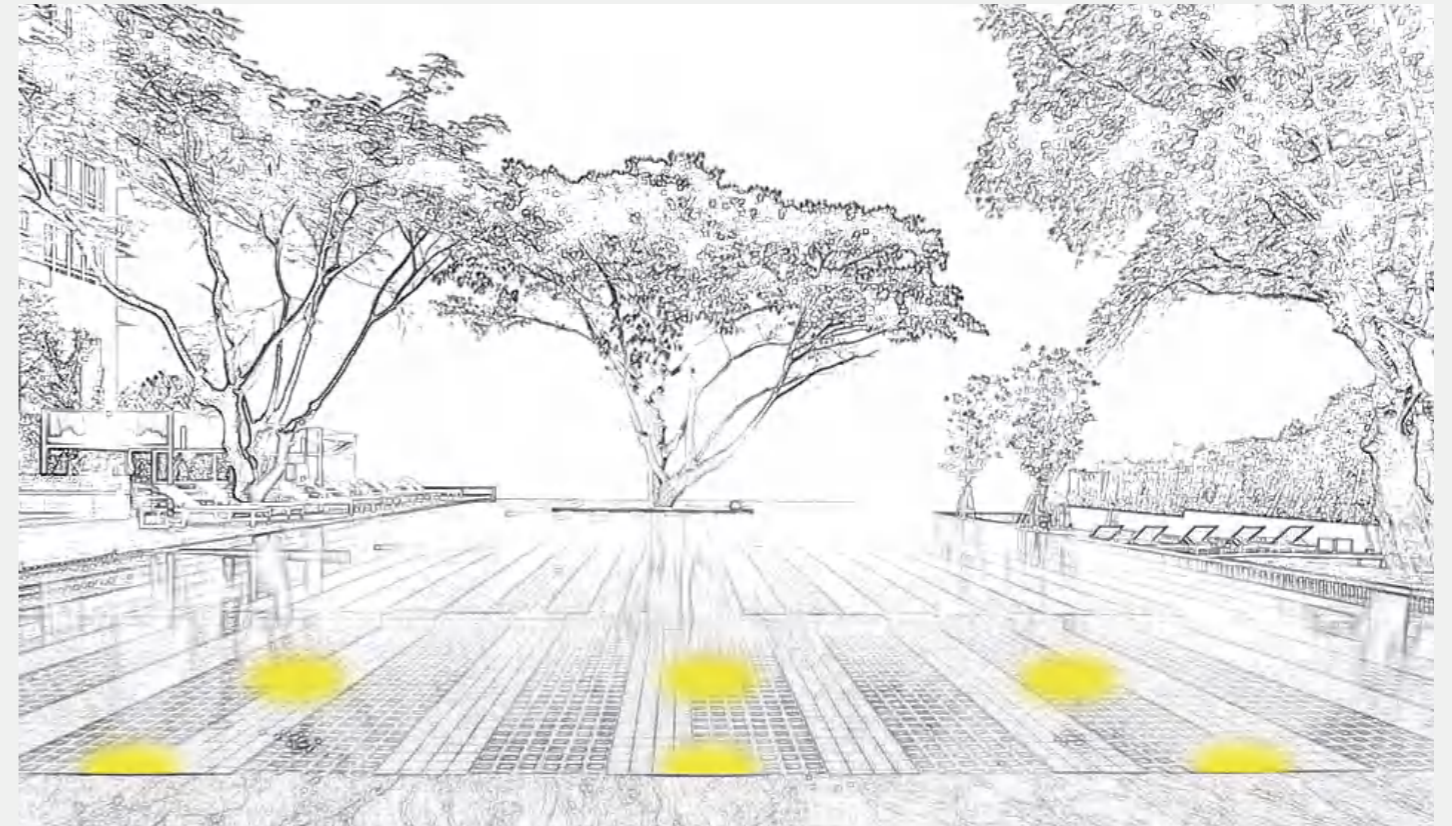

**Material Quality**

SUS 316L stainless steel housing  
Tempered glass.

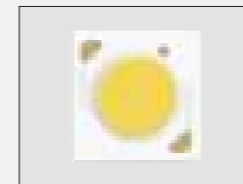

**LED**

CREE/OSRAM/BRIDGELUX,  
CRI>80(CRI>90 on request)



**Quality/Supporting**

IP68 IK10  
Life time ≥50000 hrs  
Operating temperature -20 C -40 C

# LED Recessed Underwater Light



## 4115R1\*b-B3-Y



Power	LED	CCT	IK	Luminous	Input Voltage	Beam Angle
1x8W	CREE COB	Single	IK08	400lm	12/24 VDC	15°/24°/36°/60°



## 4115R1\*b-A3-Y



Power	LED	CCT	IK	Luminous	Input Voltage	Beam Angle
3x3W	CREE/OSRAM	Single	IK08	769lm	12/24 VDC	10°/25°/40°/60°/80°/10°45°/25°45°
3x3W	OSRAM	RGB 3in 1	IK08	200lm	12/24 VDC	12°/25°/40°/60°/12°45°
3x3W	OSRAM	RGBW 4in 1	IK08	260lm	12/24 VDC	12°/25°/40°/60°/12°45°

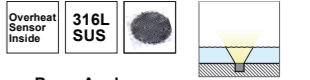

## 4145R1\*b-B3-Y



Power	LED	CCT	IK	Luminous	Input Voltage	Beam Angle
1x18W	CREE COB	Single	IK08	1440lm	12/24 VDC	15°/24°/36°/60°



## 4145R1\*b-A3-Y



Power	LED	CCT	IK	Luminous	Input Voltage	Beam Angle
6x3W	CREE/OSRAM	Single	IK08	1440lm	12/24 VDC	10°/25°/40°/60°/80°/10°45°/25°45°
6x3W	OSRAM	RGB 3in 1	IK08	450lm	12/24 VDC	12°/25°/40°/60°/12°45°
6x3.5W	OSRAM	RGBW 4in 1	IK08	630lm	12/24 VDC	12°/25°/40°/60°/12°45°

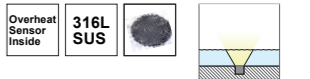

## 4170R1\*b-B3-Y

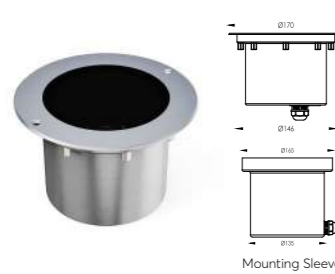

Power	LED	CCT	IK	Luminous	Input Voltage	Beam Angle
1x25W	CREE COB	Single	IK08	2000lm	12/24 VDC	15°/24°/36°/60°



## 4170R1\*b-A3-Y



Power	LED	CCT	IK	Luminous	Input Voltage	Beam Angle
12x3W	CREE/OSRAM	Single	IK08	2800lm	12/24 VDC	10°/25°/40°/60°/80°/10°45°/25°45°
12x3W	OSRAM	RGB 3in 1	IK08	900lm	12/24 VDC	12°/25°/40°/60°/12°45°
12x3W	OSRAM	RGBW 4in 1	IK08	1260lm	12/24 VDC	12°/25°/40°/60°/12°45°

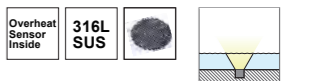

**WARNING:** Must be installed under the water to prevent the light from being burnt off because of over-heating

## LED Recessed Underwater Light



### 4135R2\*a-XX-Y/WB4150R2\*a-XX-Y

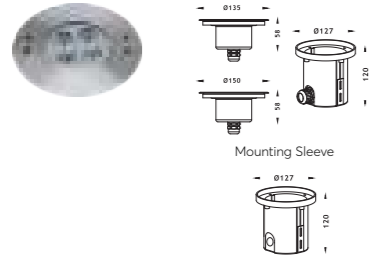

Power	LED	CCT	IK	Luminous	Input Voltage	Beam Angle
1x8W	CREE COB	Single	IK08	780lm	12/24 VDC	15°/25°/36°/60°
4x2W	CREE/OSRAM	Single	IK08	660lm	12/24 VDC	10°/25°/40°/60°/100°
4x2W	CREE/OSRAM	Single	IK08	660lm	12/24 VDC	Asy25°/45°
4x3W	OSRAM	RGB 3in 1	IK08	300lm	12/24 VDC	25°/40°/60°
4x3W	OSRAM	RGB 4in 1	IK08	420lm	12/24 VDC	25°/40°/60°

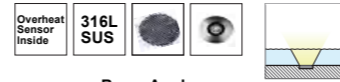

### 4205R2\*b-XX-Y

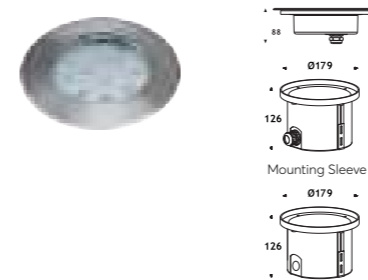

Power	LED	CCT	IK	Luminous	Input Voltage	Beam Angle
12x2W	CREE/OSRAM	Single	IK10	1920lm	12/24 VDC	10°/15°/20°/30°/60°/100°
12x2W	CREE/OSRAM	Single	IK10	1920lm	12/24 VDC	Asy25°/45°
12x3W	OSRAM	RGB 3in 1	IK10	900lm	12/24 VDC	25°/40°/60°
12x3W	OSRAM	RGB 4in 1	IK10	1260lm	12/24 VDC	25°/40°/60°



### 4180R2\*a-XX-Y

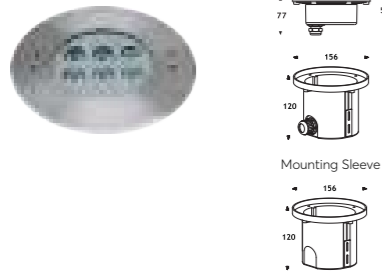

Power	LED	CCT	IK	Luminous	Input Voltage	Beam Angle
1x12W	CREE COB	Single	IK08	1150lm	12/24 VDC	15°/25°/36°/60°
6x2W	CREE/OSRAM	Single	IK08	1008lm	12/24 VDC	10°/25°/40°/60°/100°
6x2W	CREE/OSRAM	Single	IK08	1008lm	12/24 VDC	Asy25°/45°
6x3W	OSRAM	RGB 3in 1	IK08	490lm	12/24 VDC	25°/40°/60°
6x3W	OSRAM	RGB 4in 1	IK08	680lm	12/24 VDC	25°/40°/60°

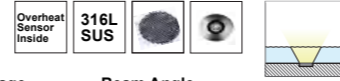

### 4250R2\*a-XX-Y

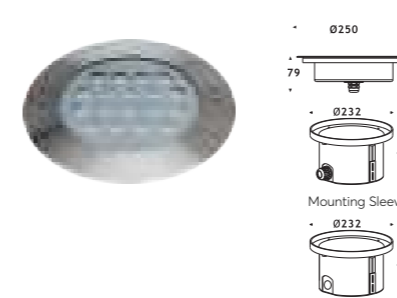

Power	LED	CCT	IK	Luminous	Input Voltage	Beam Angle
1x45W	CREE COB	Single	IK10	4500lm	12/24 VDC	15°/25°/36°/60°
18x2W	CREE/OSRAM	Single	IK10	2900lm	12/24 VDC	10°/15°/20°/30°/60°/100°
18x2W	OSRAM	Single	IK10	2900lm	12/24 VDC	Asy25°/45°
18x3W	OSRAM	RGB 3in 1	IK10	1800lm	12/24 VDC	25°/40°/60°
18x3W	OSRAM	RGB 4in 1	IK10	2500lm	12/24 VDC	25°/40°/60°



### 4180R2\*b-XX-Y



Power	LED	CCT	IK	Luminous	Input Voltage	Beam Angle
6x2W	CREE/OSRAM	Single	IK08	1180lm	12/24 VDC	10°/25°/40°/60°/100°
6x2W	CREE/OSRAM	Single	IK08	1180lm	12/24 VDC	Asy25°/45°
6x3W	OSRAM	RGB 3in 1	IK08	1180lm	12/24 VDC	25°/40°/60°
6x3W	OSRAM	RGB 4in 1	IK08	1180lm	12/24 VDC	25°/40°/60°

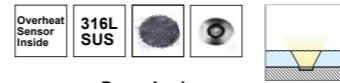

### 4250R2\*b-XX-Y



Power	LED	CCT	IK	Luminous	Input Voltage	Beam Angle
36x1.5W	CREE/OSRAM	Single	IK10	4320lm	12/24 VDC	10°/15°/20°/30°/60°/100°
36x1.5W	OSRAM	R.G.B	IK10	3240lm	12/24 VDC	15°/25°/40°/60°

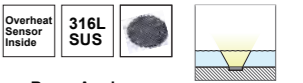

### 4205R2\*a-XX-Y

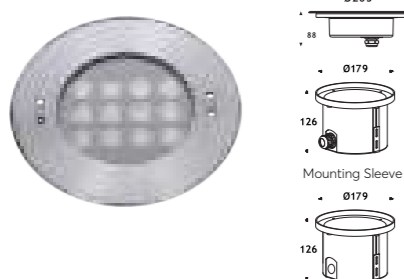

Power	LED	CCT	IK	Luminous	Input Voltage	Beam Angle
1x24W	CREE COB	Single	IK08	2300lm	12/24 VDC	15°/25°/36°/60°
12x2W	CREE/OSRAM	Single	IK08	2000lm	12/24 VDC	10°/25°/40°/60°/100°
12x2W	CREE/OSRAM	Single	IK08	2000lm	12/24 VDC	Asy25°/45°
12x3W	OSRAM	RGB 3in 1	IK08	960lm	12/24 VDC	25°/40°/60°
12x3W	OSRAM	RGB 4in 1	IK08	1350lm	12/24 VDC	25°/40°/60°

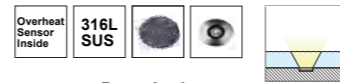

**WARNING:** Must be installed under the water to prevent the light from being burnt off because of over-heating

## LED Recessed Underwater Light

CE ERP IP68 RoHS 1-10V Triac PWM DALI RGB RGBW

### 4038R1\*α-A3-Y

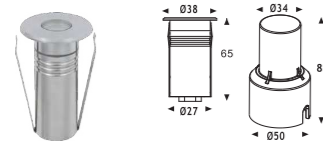

Power	LED	CCT	IK	Luminous	Input Voltage	Beam Angle
1x15W	CREE/OSRAM	Single	IK08	140lm	12/24 VDC	10°/25°/40°/60°

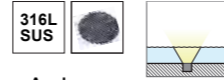

### 4118R1\*α-A3-Y

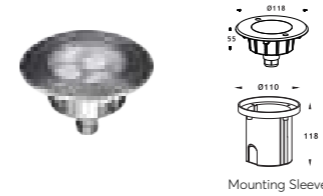

Power	LED	CCT	IK	Luminous	Input Voltage	Beam Angle
3x2W	CREE/OSRAM	Single	IK08	530lm	12/24 VDC	10°/20°/30°/60°
3x3W	OSRAM	RGB 3in 1	IK08	230lm	12/24 VDC	25°/40°/60°
3x3W	OSRAM	RGB 4in 1	IK08	320lm	12/24 VDC	25°/40°/60°

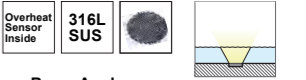

### 4055R1\*α-A3-Y



Power	LED	CCT	IK	Luminous	Input Voltage	Beam Angle
1x2W	CREE/OSRAM	Single	IK08	160lm	12/24 VDC	15°/25°/36°/60°
1x2W	CREE/OSRAM	Single	IK08	160lm	12/24 VDC	Asy25°
1x3W	OSRAM	RGB 3in 1	IK08	75lm	12/24 VDC	25°/40°/60°
1x3W	OSRAM	RGBW 4in 1	IK08	100lm	12/24 VDC	25°/40°/60°

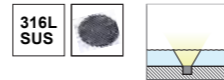

### 4162R1\*α-A3-Y

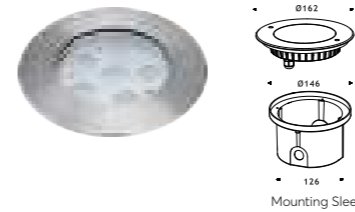

Power	LED	CCT	IK	Luminous	Input Voltage	Beam Angle
6x2W	CREE/OSRAM	Single	IK08	980lm	12/24 VDC	10°/20°/30°/60°
6x3W	OSRAM	RGB 3in 1	IK08	490lm	12/24 VDC	25°/40°/60°
6x3W	OSRAM	RGB 4in 1	IK08	680lm	12/24 VDC	25°/40°/60°

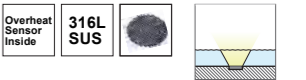

### 4068R1\*α-A3-Y



Power	LED	CCT	IK	Luminous	Input Voltage	Beam Angle
1x2W	CREE/OSRAM	Single	IK08	160lm	12/24 VDC	15°/25°/36°/60°
1x2W	CREE/OSRAM	Single	IK08	160lm	12/24 VDC	Asy25°
1x3W	OSRAM	RGB 3in 1	IK08	75lm	12/24 VDC	25°/40°/60°
1x3W	OSRAM	RGBW 4in 1	IK08	100lm	12/24 VDC	25°/40°/60°

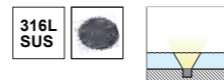

### 4162R1\*b-A3-Y



Power	LED	CCT	IK	Luminous	Input Voltage	Beam Angle
9x1.5W	CREE/OSRAM	Single	IK08	1360lm	12/24 VDC	10°/20°/30°/60°
9x1.5W	OSRAM	3R.3G.3B	IK08	980lm	12/24 VDC	15°/25°/40°/60°
9x2W	OSRAM	RGB 3in 1	IK08	660lm	12/24 VDC	25°/40°/60°
9x2W	OSRAM	RGB 4in 1	IK08	930lm	12/24 VDC	25°/40°/60°



### 4067R1\*α-A3-Y

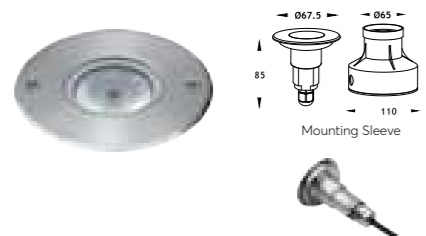

Power	LED	CCT	IK	Luminous	Input Voltage	Beam Angle
1x2W	CREE/OSRAM	Single	IK08	200lm	12/24 VDC	15°/25°/36°/60°
1x2W	CREE/OSRAM	Single	IK08	200lm	12/24 VDC	Asy25°
1x3W	OSRAM	RGB 3in 1	IK08	90lm	12/24 VDC	25°/40°/60°

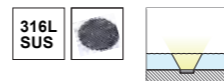

### 4185R1\*α-A3-Y



Power	LED	CCT	IK	Luminous	Input Voltage	Beam Angle
12x2W	CREE/OSRAM	Single	IK08	1920lm	12/24 VDC	10°/20°/30°/60°
12x3W	OSRAM	RGB 3in 1	IK08	900lm	12/24 VDC	25°/40°/60°
12x3W	OSRAM	RGB 4in 1	IK08	1260lm	12/24 VDC	25°/40°/60°
18x1.5W	OSRAM	Single	IK08	2000lm	12/24 VDC	25°/40°/60°



**WARNING:** Must be installed under the water to prevent the light from being burnt off because of over-heating

## LED Recessed Underwater Light



### 4063L2#a-A3-Y-0.195M

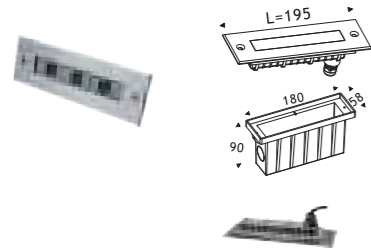

Power	LED	CCT	IK	Luminous	Input Voltage	Beam Angle
3x2W	CREE/OSRAM	Single	IK08	400lm	12/24 VDC	10°/25°/40°/60°/45°35°
3x2.5W	CREE/OSRAM	RGB 3in 1	IK08	180lm	12/24 VDC	25°/40°/60°/45°35°
3x3.5W	CREE/OSRAM	RGBW 4in 1	IK08	260lm	12/24 VDC	25°/40°/60°/45°35°

### 5063L2#a-A3-Z-0.195M

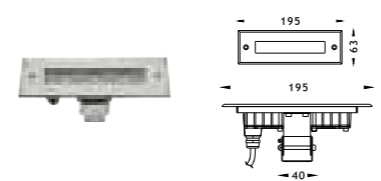

Power	LED	CCT	IK	Luminous	Input Voltage	Beam Angle
3x2W	CREE/OSRAM	Single	IK08	400lm	12/24 VDC	25°/40°/60°
3x3W	CREE/OSRAM	RGB 3in 1	IK08	180lm	12/24 VDC	25°/40°/60°
3x4W	CREE/OSRAM	RGB 4in 1	IK08	260lm	12/24 VDC	25°/40°/60°

### 4063L2#a-A3-Y-0.328M

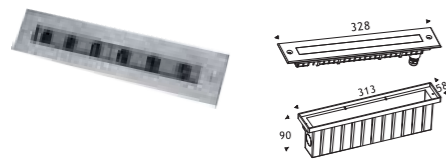

Power	LED	CCT	IK	Luminous	Input Voltage	Beam Angle
6x2W	CREE/OSRAM	Single	IK08	798lm	12/24 VDC	10°/25°/40°/60°/45°35°
6x2.5W	CREE/OSRAM	RGB 3in 1	IK08	375lm	12/24 VDC	25°/40°/60°/45°35°
6x3.5W	CREE/OSRAM	RGBW 4in 1	IK08	520lm	12/24 VDC	25°/40°/60°/45°35°

### 5063L2#a-A3-Z-0.328M

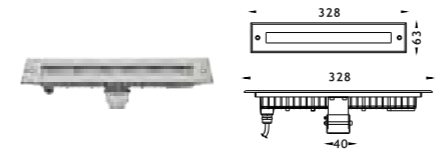

Power	LED	CCT	IK	Luminous	Input Voltage	Beam Angle
6x2W	CREE/OSRAM	Single	IK08	798lm	12/24 VDC	25°/40°/60°
6x3W	CREE/OSRAM	RGB 3in 1	IK08	375lm	12/24 VDC	25°/40°/60°
6x4W	CREE/OSRAM	RGB 4in 1	IK08	520lm	12/24 VDC	25°/40°/60°

### 4063L4#a-C7-Y-0.195M

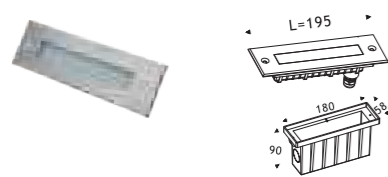

Power	LED	CCT	IK	Luminous	Input Voltage	Beam Angle
2.2W	OSRAM	Single	IK08	--	12/24 VDC	120°
2.2W	OSRAM	RGB 3in 1	IK08	--	12/24 VDC	120°

### 4063L2#a-C7-Y-0.328M



Power	LED	CCT	IK	Luminous	Input Voltage	Beam Angle
3-6W	OSRAM	Single	IK08	--	12/24 VDC	120°
3-6W	OSRAM	RGB 3in 1	IK08	--	12/24 VDC	120°

**WARNING:** Must be installed under the water to prevent the light from being burnt off because of over-heating



## LED Fountain Light

Manufactured with corrosion-resistant SUS316 stainless steel, ensuring long-term stability and durability of the underwater lights.

Waterproof Rating: Possesses excellent waterproof performance, employing special sealing design to achieve IP68 waterproofing, ensuring reliable operation in underwater environments.

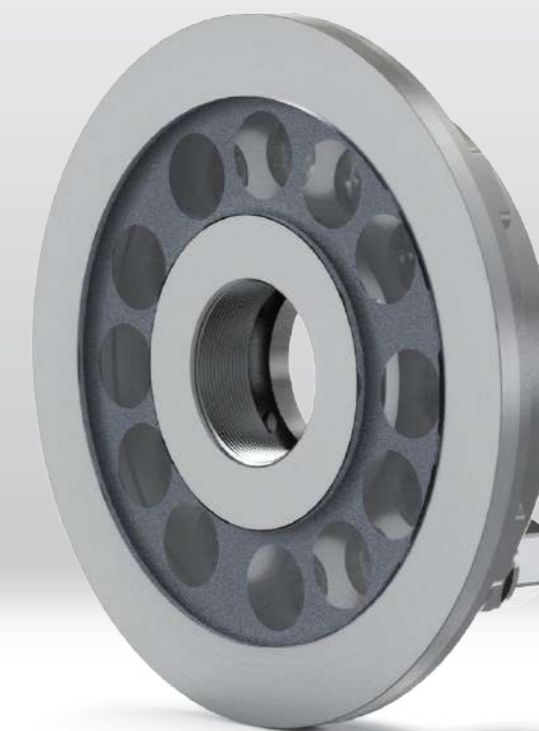



## RGB/RGBW

Diverse Lighting Effects:  
The underwater lights offer a variety of lighting effects and color options, including mono color, multi-color, gradient, and flashing. By using controller or remote, the brightness, color, and mode of the lights can be easily adjusted, creating different underwater visual effects and adding charm and amusement.

LED Fountain Light

Website: [WWW.iliteuk.com](http://WWW.iliteuk.com)

Email: [sales@iliteuk.com](mailto:sales@iliteuk.com)

Address: 1 Hatton Street, London, United Kingdom, NW8 8PL



LED Fountain Light

Website: [WWW.iliteuk.com](http://WWW.iliteuk.com)

Email: [sales@iliteuk.com](mailto:sales@iliteuk.com)

Address: 1 Hatton Street, London, United Kingdom, NW8 8PL



**Series UR**

Diverse Lighting Effects:  
The underwater lights offer a variety of lighting effects and color options.

Including single color, multi-color, gradient, and flashing.

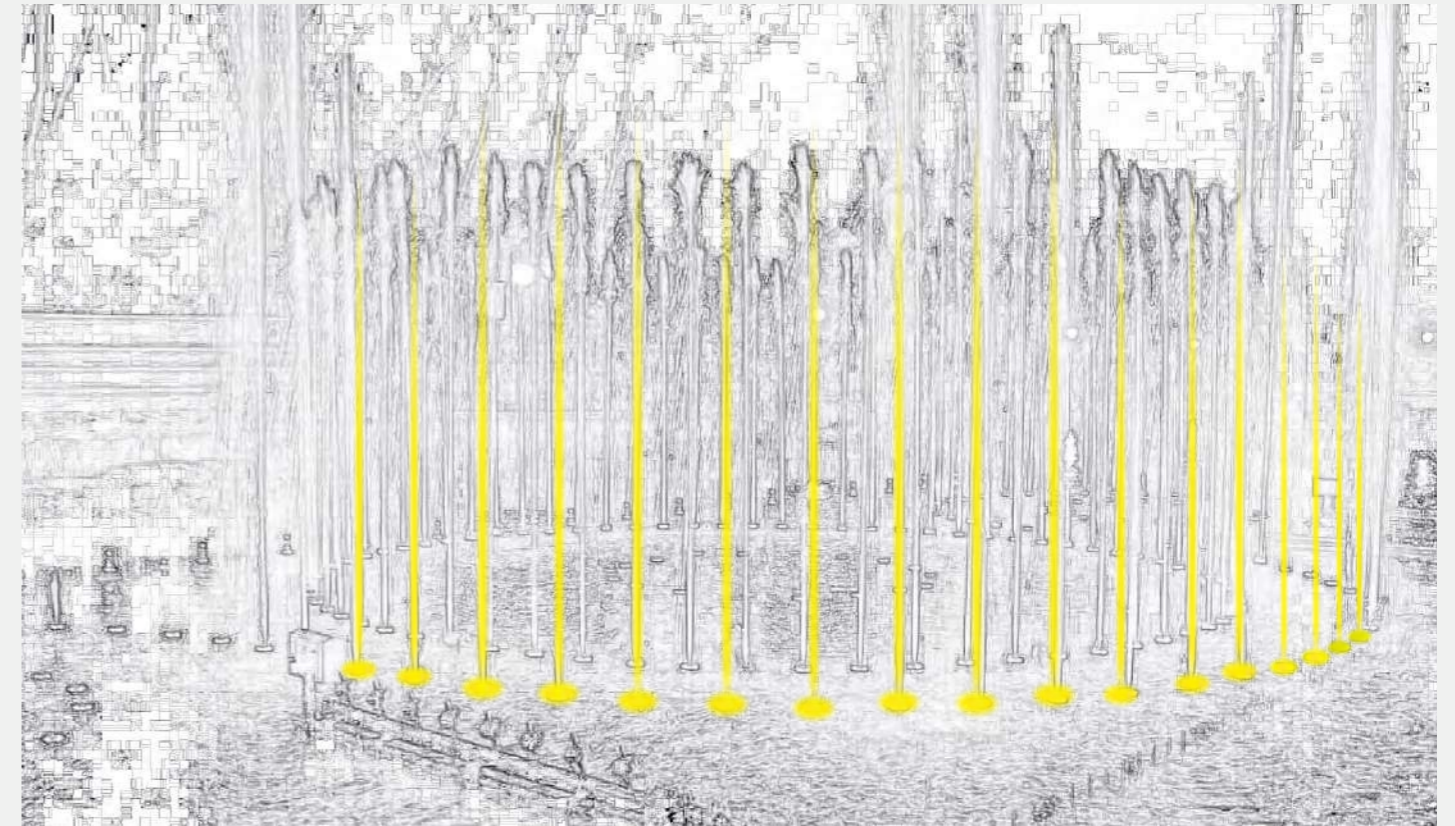

**Material Quality**

SUS 316L stainless steel housing  
Tempered glass

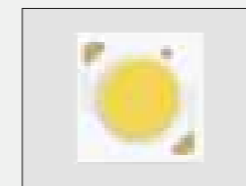

**LED**

CREE/OSRAM/BRIDGELUX,  
CRI>80(CRI>90 on request)



**Quality/Supporting**

IP68 IK10  
Life time ≥50000 hrs  
Operating temperature -20 C ~40 C

By using a controller or remote, the brightness, color, and mode of the lights can be easily adjusted, creating different underwater visual effects and adding charm and amusement.

# LED Fountain Light



## 4182R1\*α-A3-T-09

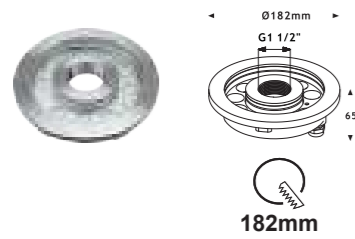

Power	LED	CCT	IK	Luminous	Input Voltage	Beam Angle
9x2W	CREE/OSRAM	Single	IK08	1450lm	12/24 VDC	10°/25°/40°/60°/10°30°/10°60°
9x2.5W	OSRAM	RGB 3in 1	IK08	690lm	12/24 VDC	25°/40°/60°/10°30°/10°60°
9x3.5W	OSRAM	RGBW 4in 1	IK08	960lm	12/24 VDC	25°/40°/60°/10°30°/10°60°



## 4149R1\*α-A3-T

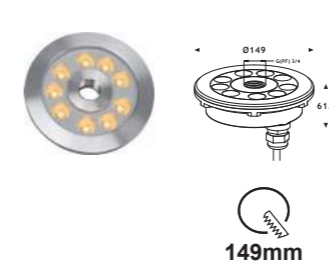

Power	LED	CCT	IK	Luminous	Input Voltage	Beam Angle
9x2W	CREE/OSRAM	Single	IK08	1450lm	12/24 VDC	10°/25°/40°/60°/10°30°/10°60°
9x2.5W	OSRAM	RGB 3in 1	IK08	690lm	12/24 VDC	25°/40°/60°/10°30°/10°60°
9x3.5W	OSRAM	RGBW 4in 1	IK08	960lm	12/24 VDC	25°/40°/60°/10°30°/10°60°

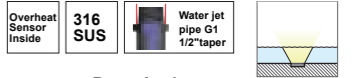

## 4182R1\*α-A3-T-12

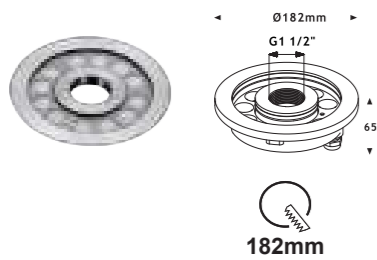

Power	LED	CCT	IK	Luminous	Input Voltage	Beam Angle
12x2W	CREE/OSRAM	Single	IK08	1950lm	12/24 VDC	10°/25°/40°/60°/10°30°/10°60°
12x2.5W	OSRAM	RGB 3in 1	IK08	900lm	12/24 VDC	25°/40°/60°/10°30°/10°60°
12x3.5W	OSRAM	RGBW 4in 1	IK08	1260lm	12/24 VDC	25°/40°/60°/10°30°/10°60°



## 4170R1\*α-A3-T

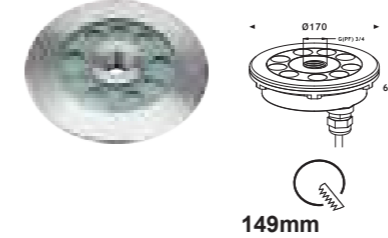

Power	LED	CCT	IK	Luminous	Input Voltage	Beam Angle
9x2W	CREE/OSRAM	Single	IK08	1450lm	12/24 VDC	10°/25°/40°/60°/10°30°/10°60°
9x2.5W	OSRAM	RGB 3in 1	IK08	690lm	12/24 VDC	25°/40°/60°/10°30°/10°60°
9x3.5W	OSRAM	RGBW 4in 1	IK08	960lm	12/24 VDC	25°/40°/60°/10°30°/10°60°

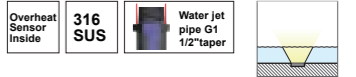

## 4200R1\*α-A3-T-09

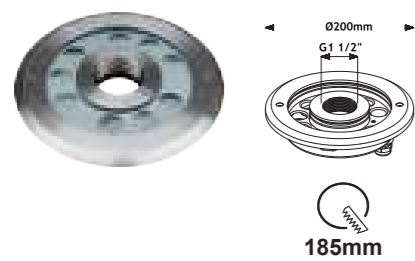

Power	LED	CCT	IK	Luminous	Input Voltage	Beam Angle
9x2W	CREE/OSRAM	Single	IK08	1450lm	12/24 VDC	10°/25°/40°/60°/10°30°/10°60°
9x2.5W	OSRAM	RGB 3in 1	IK08	690lm	12/24 VDC	25°/40°/60°/10°30°/10°60°
9x3.5W	OSRAM	RGBW 4in 1	IK08	960lm	12/24 VDC	25°/40°/60°/10°30°/10°60°



## 4115R1\*α-A3-T

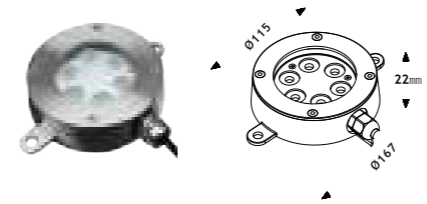

Power	LED	CCT	IK	Luminous	Input Voltage	Beam Angle
6x2W	CREE/OSRAM	Single	IK08	1020lm	12/24 VDC	10°/25°/40°/60°/10°30°/10°60°
6x2.5W	OSRAM	RGB 3in 1	IK08	450lm	12/24 VDC	25°/40°/60°/10°30°/10°60°
6x3.5W	OSRAM	RGBW 4in 1	IK08	630lm	12/24 VDC	25°/40°/60°/10°30°/10°60°

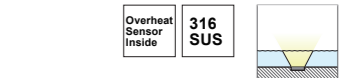

## 4200R1\*α-A3-T-12

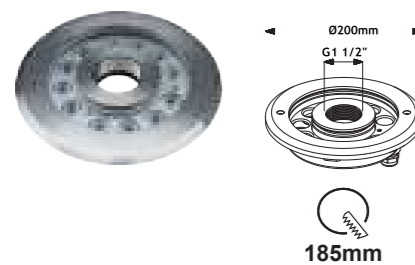

Power	LED	CCT	IK	Luminous	Input Voltage	Beam Angle
12x2W	CREE/OSRAM	Single	IK08	1950lm	12/24 VDC	10°/25°/40°/60°/10°30°/10°60°
12x2.5W	OSRAM	RGB 3in 1	IK08	900lm	12/24 VDC	25°/40°/60°/10°30°/10°60°
12x3.5W	OSRAM	RGBW 4in 1	IK08	1260lm	12/24 VDC	25°/40°/60°/10°30°/10°60°



## 4160R1\*α-A3-T

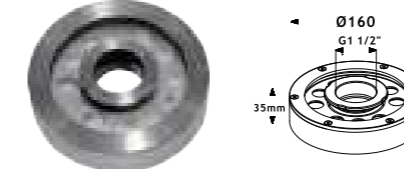

Power	LED	CCT	IK	Luminous	Input Voltage	Beam Angle
9x2W	CREE/OSRAM	Single	IK08	1450lm	12/24 VDC	10°/25°/40°/60°/10°30°/10°60°
9x2.5W	OSRAM	RGB 3in 1	IK08	690lm	12/24 VDC	25°/40°/60°/10°30°/10°60°
9x3.5W	OSRAM	RGBW 4in 1	IK08	960lm	12/24 VDC	25°/40°/60°/10°30°/10°60°



**WARNING:** Must be installed under the water to prevent the light from being burnt off because of over-heating

## HIGH POWER



## REFLECTIVE CUP



## COB



## LED Underwater Light

Manufactured with corrosion-resistant 316 stainless steel, ensuring long-term stability and durability of the underwater lights.

Waterproof Rating: Possesses excellent waterproof performance, employing special sealing design to achieve an IP68 waterproof rating, ensuring reliable operation in underwater environments.

## Series UT

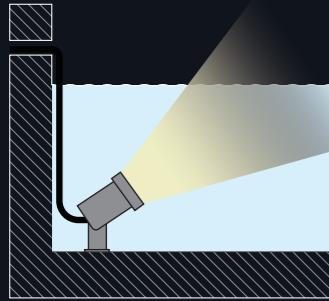

Ground Mounted

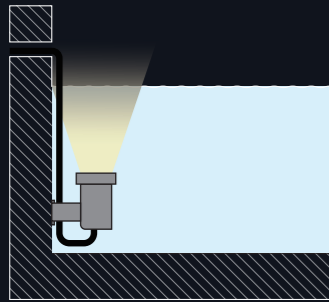

Wall Mounted



12 PCS

Controllable Angle

IK08/IP68

LED Underwater Light

Website: [WWW.iliteuk.com](http://WWW.iliteuk.com)

Email: [sales@iliteuk.com](mailto:sales@iliteuk.com)

Address: 1 Hatton Street, London, United Kingdom, NW8 8PL



LED Underwater Light

Website: [WWW.iliteuk.com](http://WWW.iliteuk.com)

Email: [sales@iliteuk.com](mailto:sales@iliteuk.com)

Address: 1 Hatton Street, London, United Kingdom, NW8 8PL

## Series UT

Diverse Lighting Effects: The underwater lights offer a variety of lighting effects and color options, including mono color, multi-color, gradient, and flashing.

By using controller or remote, the brightness, color, and mode of the lights can be easily adjusted, creating different underwater visual effects and adding charm and amusement.



Easily adjust the brightness, color, and mode of lights



## LED Underwater Spot Light



### 5042R1\*α-B3-Z

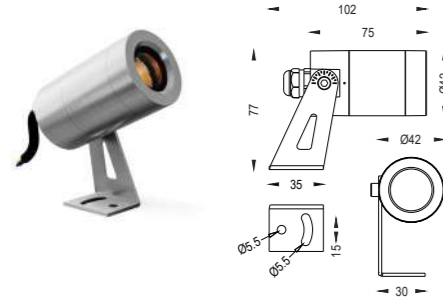
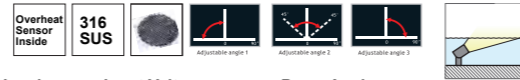

Power	LED	CCT	IK	Luminous	Input Voltage	Beam Angle
1x4W	CREE COB	Single	IK08	300lm	12/24 VDC	15°/24°/36°/55°
1x3W	OSRAM	Single	IK08	210lm	12/24 VDC	10°/25°/40°/60°/80°/10°45°/25°45°
1x3W	OSRAM	RGB 3in 1	IK08	75lm	12/24 VDC	25°/40°/60°
1x4W	OSRAM	RGBW 4in 1	IK08	100lm	12/24 VDC	25°/40°/60°

### 5095R1\*α-XX-Z

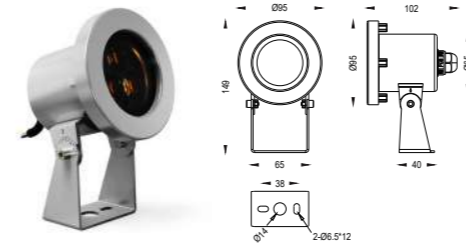
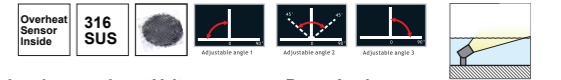

Power	LED	CCT	IK	Luminous	Input Voltage	Beam Angle
1x6W	CREE COB	Single	IK08	400lm	12/24 VDC	12°/24°/35°
3x2W	CREE/OSRAM	Single	IK08	520lm	12/24 VDC	10°/25°/40°/60°/80°/10°45°/25°45°
3x2.5W	OSRAM	RGB 3in 1	IK08	200lm	12/24 VDC	25°/40°/60°
3x3.5W	OSRAM	RGBW 4in 1	IK08	260lm	12/24 VDC	25°/40°/60°

### 5065R1\*α-XX-Z

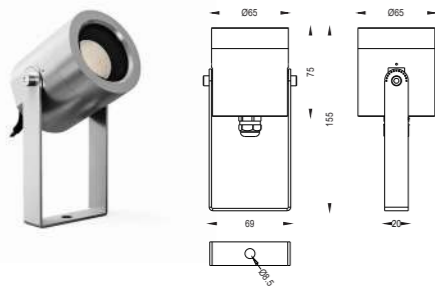
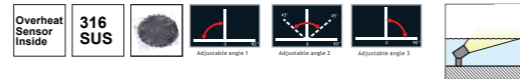

Power	LED	CCT	IK	Luminous	Input Voltage	Beam Angle
1x6W	CREE COB	Single	IK08	540lm	12/24 VDC	15°/24°/36°/55°
3x2W	OSRAM	Single	IK08	300lm	12/24 VDC	10°/25°/40°/60°/80°/10°45°/25°45°
3x2.5W	OSRAM	RGB 3in 1	IK08	200lm	12/24 VDC	25°/40°/60°
3x3.5W	OSRAM	RGBW 4in 1	IK08	260lm	12/24 VDC	25°/40°/60°

### 5125R1\*α-XX-Z

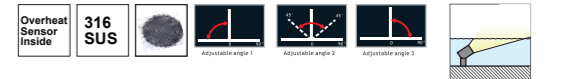

Power	LED	CCT	IK	Luminous	Input Voltage	Beam Angle
1x15W	CREE COB	Single	IK08	1200lm	24 VDC	15°/24°/36°/55°
6x2.5W	CREE/OSRAM	Single	IK08	120lm	12/24 VDC	10°/25°/40°/60°/80°/10°45°/25°45°
6x2.5W	OSRAM	RGB 3in 1	IK08	450lm	12/24 VDC	25°/40°/60°
6x3.5W	OSRAM	RGBW 4in 1	IK08	630lm	12/24 VDC	25°/40°/60°

### 5224R1\*α-XX-Z

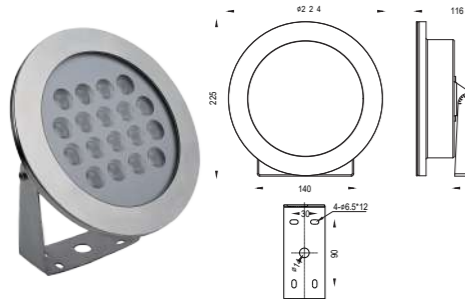
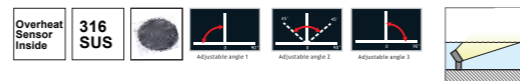

Power	LED	CCT	IK	Luminous	Input Voltage	Beam Angle
1x45W	CREE COB	Single	IK08	4500lm	24 VDC	15°/24°/36°/55°
18x2W	CREE/OSRAM	Single	IK08	2400lm	12/24 VDC	10°/25°/40°/60°/80°/10°45°/25°45°
18x2.5W	OSRAM	RGB 3in 1	IK08	1800lm	12/24 VDC	25°/40°/60°
18x3.5W	OSRAM	RGBW 4in 1	IK08	2900lm	12/24 VDC	25°/40°/60°

### 5150R1\*α-XX-Z

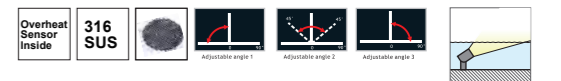

Power	LED	CCT	IK	Luminous	Input Voltage	Beam Angle
1x20W	CREE COB	Single	IK08	1600lm	24 VDC	15°/24°/36°/55°
12x2.5W	CREE/OSRAM	Single	IK08	2400lm	12/24 VDC	10°/25°/40°/60°/80°/10°45°/25°45°
12x2.5W	OSRAM	RGB 3in 1	IK08	900lm	12/24 VDC	25°/40°/60°
12x3.5W	OSRAM	RGBW 4in 1	IK08	1260lm	12/24 VDC	25°/40°/60°

**WARNING:** Must be installed under the water to prevent the light from being burnt off because of over-heating

## LED Underwater Spot Light



### 5061R1\*α-A3-M

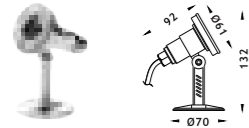

Power	LED	CCT	IK	Luminous	Input Voltage	Beam Angle
1x2W	OSRAM	Single	IK08	160lm	12/24 VDC	15°/30°/45°/60°
1x3W	OSRAM	RGB 3in 1	IK08	70lm	12/24 VDC	25°/40°/60°

### 5130R1\*α-A3-Z-09

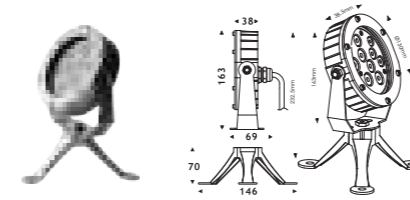

Power	LED	CCT	IK	Luminous	Input Voltage	Beam Angle
9x2W	CREE/OSRAM	Single	IK08	1200lm	12/24 VDC	15°/30°/45°/60°
9x2.5W	OSRAM	RGB 3in 1	IK08	560lm	12/24 VDC	15°/30°/45°/60°

### 5113R1\*α-A3-Z

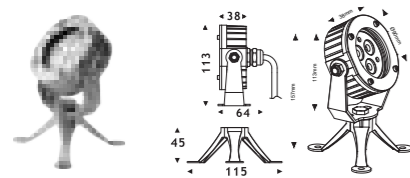

Power	LED	CCT	IK	Luminous	Input Voltage	Beam Angle
1x6W	CREE COB	Single	IK08	480lm	12/24 VDC	15°/30°/45°/60°
3x2W	CREE/OSRAM	Single	IK08	360lm	12/24 VDC	15°/30°/45°/60°
3x3W	OSRAM	RGB 3in 1	IK08	200lm	12/24 VDC	15°/30°/45°/60°

### 5158R1\*α-A3-Z

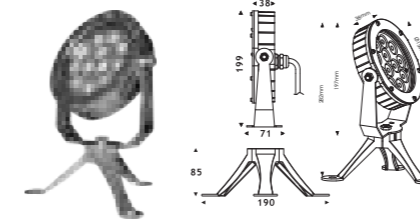

Power	LED	CCT	IK	Luminous	Input Voltage	Beam Angle
12x2W	CREE/OSRAM	Single	IK08	1600lm	12/24 VDC	15°/30°/45°/60°
12x3W	OSRAM	RGB 3in 1	IK08	900lm	12/24 VDC	15°/30°/45°/60°
12x4W	OSRAM	RGBW 4in 1	IK08	1200lm	12/24 VDC	15°/30°/45°/60°

### 5113R1\*α-A3-M

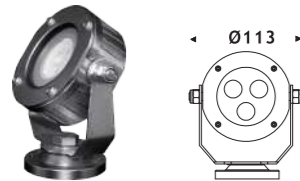

Power	LED	CCT	IK	Luminous	Input Voltage	Beam Angle
1x6W	CREE COB	Single	IK08	480lm	12/24 VDC	15°/30°/45°/60°
3x2W	CREE/OSRAM	Single	IK08	360lm	12/24 VDC	15°/30°/45°/60°
3x3W	OSRAM	RGB 3in 1	IK08	200lm	12/24 VDC	15°/30°/45°/60°

### 5220R1\*α-A3-Z

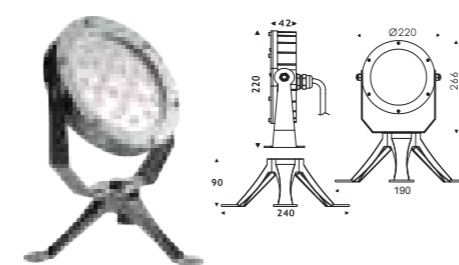

Power	LED	CCT	IK	Luminous	Input Voltage	Beam Angle
24x2W	CREE/OSRAM	Single	IK08	3120lm	12/24 VDC	15°/30°/45°/60°
24x2.5W	OSRAM	RGB 3in 1	IK08	1800lm	12/24 VDC	15°/30°/45°/60°
24x3W	OSRAM	RGBW 4in 1	IK08	2400lm	12/24 VDC	15°/30°/45°/60°

### 5130R1\*α-A3-Z-06

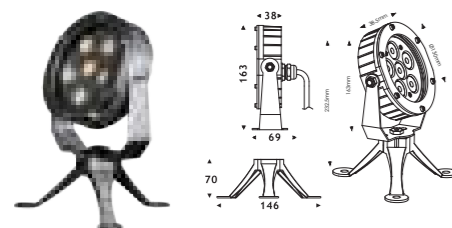

Power	LED	CCT	IK	Luminous	Input Voltage	Beam Angle
6x2W	CREE/OSRAM	Single	IK08	780lm	12/24 VDC	15°/30°/45°/60°
6x3W	OSRAM	RGB 3in 1	IK08	450lm	12/24 VDC	15°/30°/45°/60°
6x4W	OSRAM	RGBW 4in 1	IK08	600lm	12/24 VDC	15°/30°/45°/60°

**WARNING:** Must be installed under the water to prevent the light from being burnt off because of over-heating

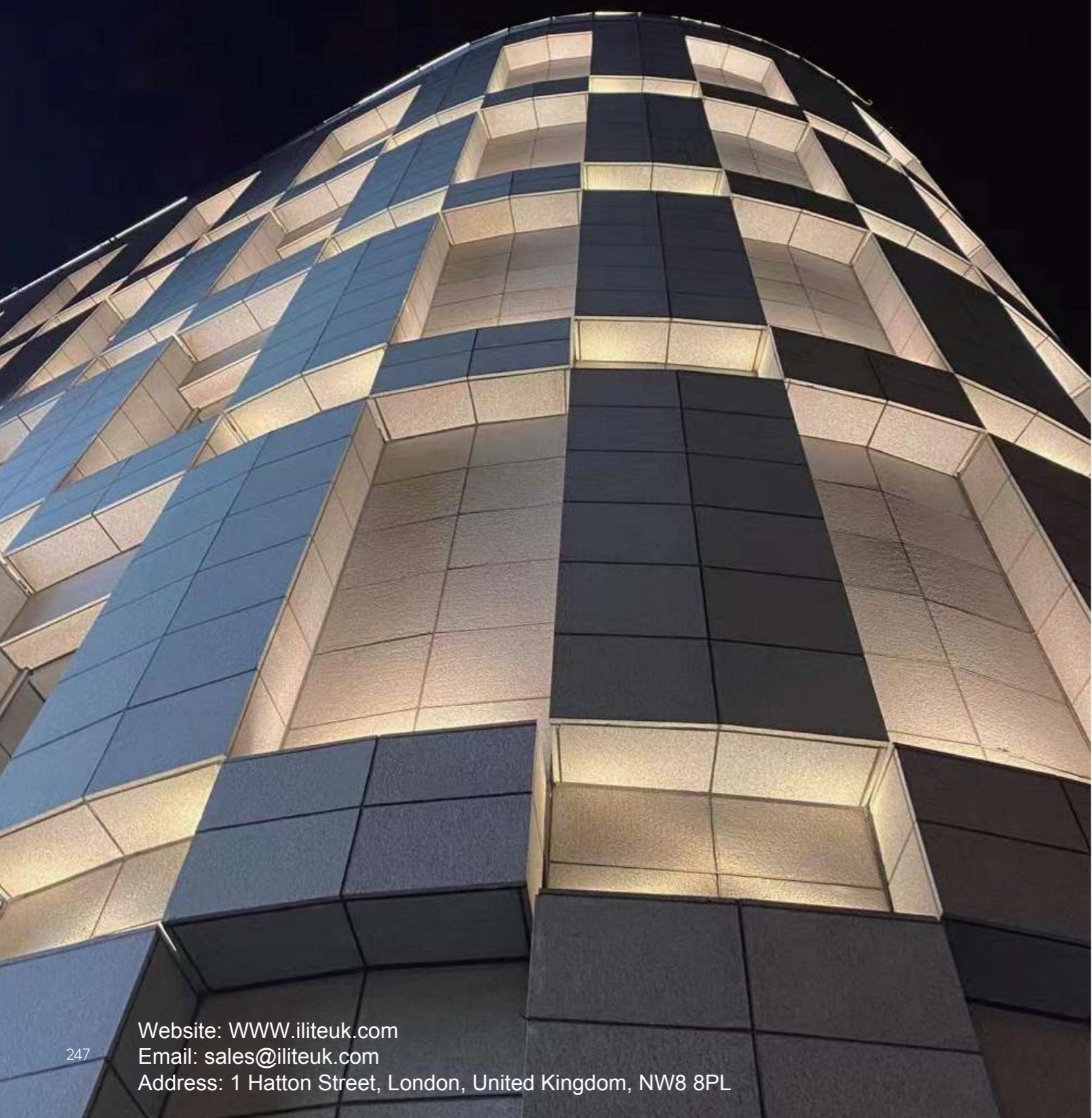

## LED Linear Wall Washer Light

Use 6063# aluminum material for our components, known for its excellent heat dissipation properties.

The surface coating meets the Class III rating in the paint adhesion test and offers a certain level of corrosion resistance.

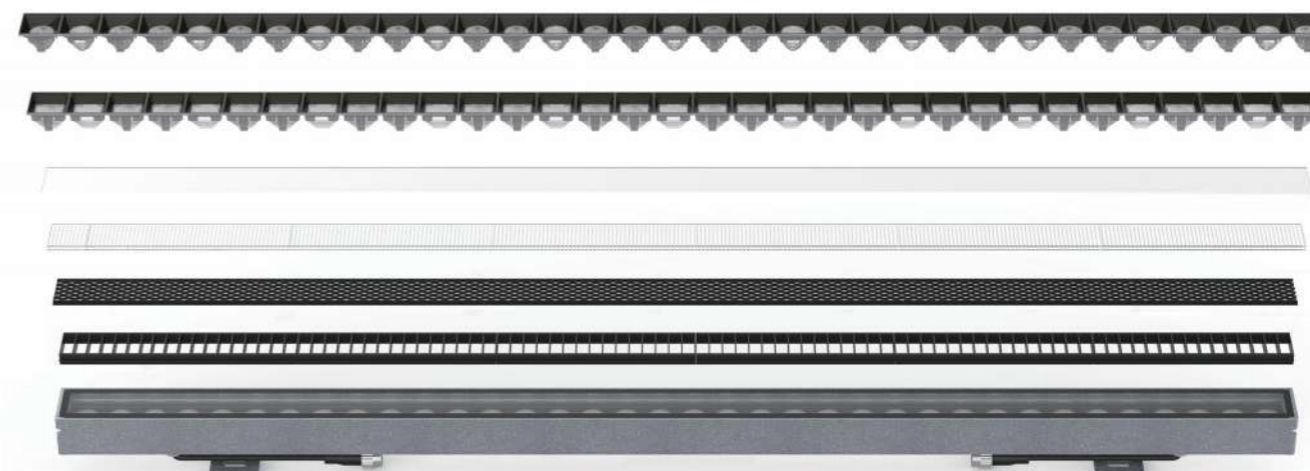



LED-Wall washer Light

Website: [WWW.iliteuk.com](http://WWW.iliteuk.com)

Email: [sales@iliteuk.com](mailto:sales@iliteuk.com)

Address: 1 Hatton Street, London, United Kingdom, NW8 8PL

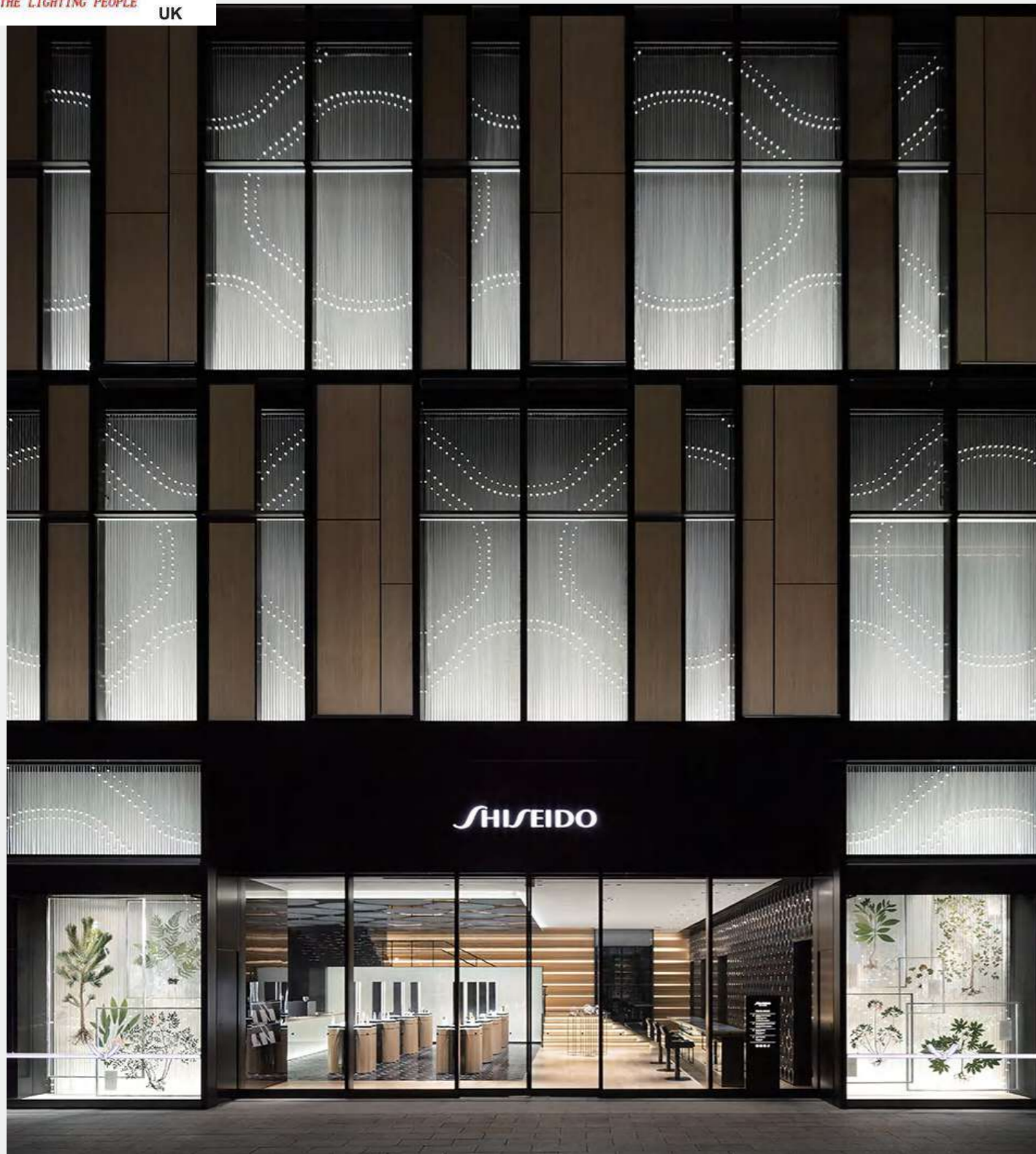

**Washer Light**

We utilize OSRAM LED chips from a leading international brand, with a color rendering index (CRI) of 80 (optional 90, 95, or full spectrum) and uniform light distribution.

spine, the carabiner's strongest axis. The light fixtures incorporate various anti-glare accessories, enabling a UGR less than 16



**Material Quality**

12# Die-casting powder coated aluminum housing  
Tempered glass

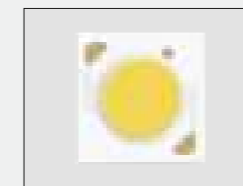

**LED**

CREE/OSRAM/BRIDGELUX, CRI>80(CRI>90 on request)  
Cable 0.25m



**Quality/Supporting**

IP65 IK05  
Life time ≥50000 hrs  
Operating temperature -20 C ~40 C

## LED Wall washer Light



### 6025L2\* $\alpha$ -A3-Z-0.3M/0.5M/1M

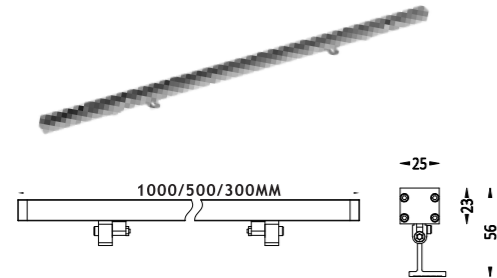

Power	LED	CCT	IK	Luminous	Input Voltage	Beam Angle
6-10W(0.3M)	OSRAM	Single	IK05	700lm	12/24 VDC/220-240VAC	15°/20°/30°/45°/10°65°
9-14W(0.5M)	OSRAM	Single	IK05	1100lm	12/24 VDC/220-240VAC	15°/20°/30°/45°/10°65°
18-28W(1M)	OSRAM	Single	IK05	2380lm	12/24 VDC/220-240VAC	15°/20°/30°/45°/10°65°

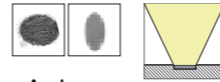

### 6050L2\* $\alpha$ -A3-Z-/0.5M/1M

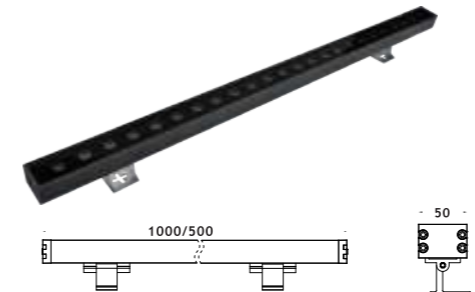

Power	LED	CCT	IK	Luminous	Input Voltage	Beam Angle
24W(0.5M)	OSRAM	Single	IK08	1390lm	12/24 VDC/220-240VAC	10°/15°/30°/60°/15°45°/10°60°
48W(1M)	OSRAM	Single	IK08	2870lm	12/24 VDC/220-240VAC	10°/15°/30°/60°/15°45°/10°60°
60W(1M)	OSRAM	RGB 3in 1	IK08	1680lm	12/24 VDC/220-240VAC	10°/15°/30°/60°/15°45°/10°60°
84W(1M)	OSRAM	RGBW 4in 1	IK08	2350lm	12/24 VDC/220-240VAC	10°/15°/30°/60°/15°45°/10°60°

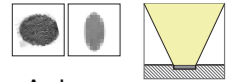

### 6025L2\* $\beta$ -A3-Z-0.3M/0.5M/1M

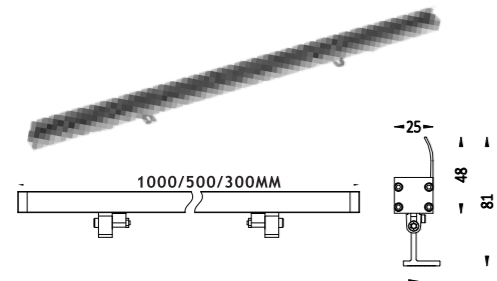

Power	LED	CCT	IK	Luminous	Input Voltage	Beam Angle
6-10W(0.3M)	OSRAM	Single	IK05	700lm	12/24 VDC/220-240VAC	15°/20°/30°/45°/10°65°
9-14W(0.5M)	OSRAM	Single	IK05	1100lm	12/24 VDC/220-240VAC	15°/20°/30°/45°/10°65°
18-28W(1M)	OSRAM	Single	IK05	2380lm	12/24 VDC/220-240VAC	15°/20°/30°/45°/10°65°

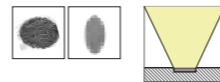

### 6072L2\* $\alpha$ -A3-Z-0.5M/1M



Power	LED	CCT	IK	Luminous	Input Voltage	Beam Angle
36W(0.5M)	OSRAM	Single	IK08	2080lm	12/24 VDC/220-240VAC	10°/15°/30°/60°/15°45°/10°60°
72W(1M)	OSRAM	Single	IK08	4180lm	12/24 VDC/220-240VAC	10°/15°/30°/60°/15°45°/10°60°
108W(1M)	OSRAM	RGB 3in 1	IK08	3140lm	12/24 VDC/220-240VAC	10°/15°/30°/60°/15°45°/10°60°
144W(1M)	OSRAM	RGBW 4in 1	IK08	4180lm	12/24 VDC/220-240VAC	10°/15°/30°/60°/15°45°/10°60°

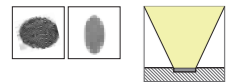

### 6042L2\* $\alpha$ -A3-Z-0.3M/0.5M/1M

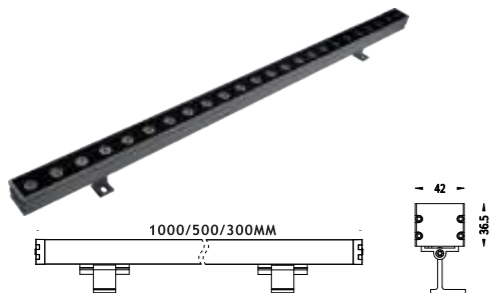

Power	LED	CCT	IK	Luminous	Input Voltage	Beam Angle
6-9W(0.3M)	OSRAM	Single	IK05	720lm	12/24 VDC/220-240VAC	10°/24°/36°/60°/15°45°/10°60°
12-18W(0.5M)	OSRAM	Single	IK05	1400lm	12/24 VDC/220-240VAC	10°/24°/36°/60°/15°45°/10°60°
24-48W(1M)	OSRAM	Single	IK05	3800lm	12/24 VDC/220-240VAC	10°/24°/36°/60°/15°45°/10°60°
24-60W(1M)	OSRAM	RGB 3in 1	IK05	1700lm	12/24 VDC	10°/24°/36°/60°/15°45°/10°60°
72W(1M)	OSRAM	RGBW 4in 1	IK05	2500lm	12/24 VDC	10°/24°/36°/60°/15°45°/10°60°

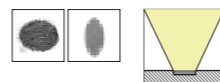

### 6042L2\* $\beta$ -A3-Z-0.3M/0.5M/1M

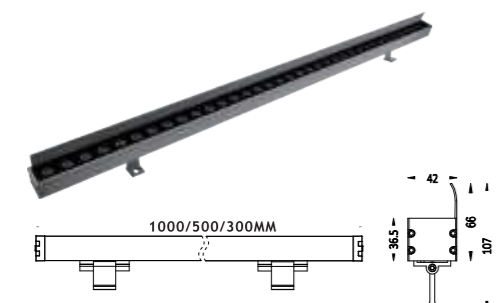

Power	LED	CCT	IK	Luminous	Input Voltage	Beam Angle
6-9W(0.3M)	OSRAM	Single	IK05	720lm	12/24 VDC/220-240VAC	10°/24°/36°/60°/15°45°/10°60°
12-18W(0.5M)	OSRAM	Single	IK05	1400lm	12/24 VDC/220-240VAC	10°/24°/36°/60°/15°45°/10°60°
24-48W(1M)	OSRAM	Single	IK05	3800lm	12/24 VDC/220-240VAC	10°/24°/36°/60°/15°45°/10°60°
24-60W(1M)	OSRAM	RGB 3in 1	IK05	1700lm	12/24 VDC	10°/24°/36°/60°/15°45°/10°60°
72W(1M)	OSRAM	RGBW 4in 1	IK05	2500lm	12/24 VDC	10°/24°/36°/60°/15°45°/10°60°

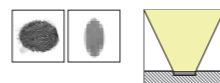

## LED Ceiling Light

Use 6063# aluminum material for our components, known for its excellent heat dissipation properties.

36 PCS LED



## Outdoor Light

The surface coating meets the Class III rating in the paint adhesion test and offers a certain level of corrosion resistance.



LED Ceiling Light

Website: [WWW.iliteuk.com](http://WWW.iliteuk.com)

Email: [sales@iliteuk.com](mailto:sales@iliteuk.com)

Address: 1 Hatton Street, London, United Kingdom, NW8 8PL



LED Ceiling Light

Website: [WWW.iliteuk.com](http://WWW.iliteuk.com)  
Email: [sales@iliteuk.com](mailto:sales@iliteuk.com)  
Address: 1 Hatton Street, London, United Kingdom, NW8 8PL



**LED Ceiling Light**

We utilize OSRAM LED chips from a leading international brand, with a color rendering index (CRI) of 80 (optional 90, 95, or full spectrum) and uniform light distribution.

spine, the carabiner's strongest axis. The light fixtures incorporate various anti-glare accessories, enabling a UGR less than 16



**Material Quality**

12# Die-casting powder coated aluminum housing  
Tempered glass

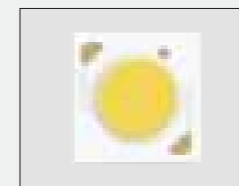

**LED**

CREE/OSRAM/BRIDGELUX,  
CRI>80(CRI>90 on request)



**Quality/Supporting**

IP65 IK05  
Life time ≥50000 hrs  
Operating temperature -20 C ~40 C

## LED IP66 Ceiling Light



### 7128R1\*a-XX-X

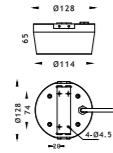

Power	LED	CCT	IK	Luminous	Input Voltage	Beam Angle
6x2.5W	CREE/OSRAM	Single	IK05	900lm	12/24 VDC/220-240VAC	10°/30°/40°/60°/90°/10°45°/20°65°
1x15W	CREE COB	Single	IK05	1200lm	12/24 VDC/220-240VAC	15°/24°/36°/60°

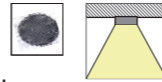

### 7170S1\*a-XX-X

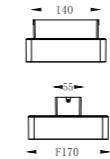

Power	LED	CCT	IK	Luminous	Input Voltage	Beam Angle
12x2W	OSRAM/CREE	Single	IK05	900lm	12/24 VDC/220-240VAC	15°/25°/40°/60°/90°
2x12W	CREE COB	Single	IK05	1200lm	12/24 VDC/220-240VAC	20°/36°/60°

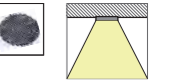

### 7168R1\*a-XX-X

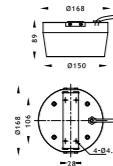

Power	LED	CCT	IK	Luminous	Input Voltage	Beam Angle
12x2.5W	CREE/OSRAM	Single	IK05	2100lm	12/24 VDC/220-240VAC	10°/30°/40°/60°/90°/10°45°/20°65°
1x30W	CREE COB	Single	IK05	3000lm	12/24 VDC/220-240VAC	15°/24°/36°/60°

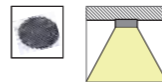

### 7210S1\*a-XX-X

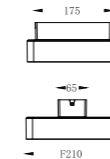

Power	LED	CCT	IK	Luminous	Input Voltage	Beam Angle
24x1.5W	OSRAM/CREE	Single	IK05	3200lm	12/24 VDC/220-240VAC	15°/25°/40°/60°/90°
4x10W	CREE COB	Single	IK05	3600lm	12/24 VDC/220-240VAC	20°/36°/60°

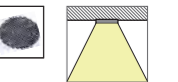

### 7208R1\*a-XX-X

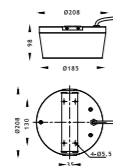

Power	LED	CCT	IK	Luminous	Input Voltage	Beam Angle
24x2W	CREE/OSRAM	Single	IK05	3080lm	12/24 VDC/220-240VAC	10°/30°/40°/60°/90°/10°45°/20°65°
4x12W	CREE COB	Single	IK05	4050lm	12/24 VDC/220-240VAC	15°/24°/36°/60°

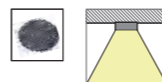

### 7260S1\*a-XX-X

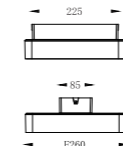

Power	LED	CCT	IK	Luminous	Input Voltage	Beam Angle
36x1.5W	OSRAM/CREE	Single	IK05	4320lm	12/24 VDC/220-240VAC	15°/25°/40°/60°/90°
4x13W	CREE COB	Single	IK05	5670lm	12/24 VDC/220-240VAC	20°/36°/60°

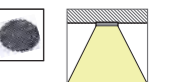

### 7258R1\*a-XX-X

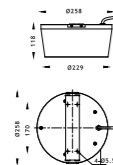

Power	LED	CCT	IK	Luminous	Input Voltage	Beam Angle
36x1.5W	CREE/OSRAM	Single	IK05	3850lm	12/24 VDC/220-240VAC	15°/25°/40°/60°/90°
4x13W	CREE COB	Single	IK05	4950lm	12/24 VDC/220-240VAC	20°/36°/60°

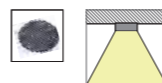

## LED Recessed Ceiling Light

The lights are manufactured with high-quality 12# die-cast aluminum, ensuring durability and weather resistance to withstand various outdoor environments. The chosen material guarantees stability and a long lifespan for the lighting fixtures.

The lights are specifically designed with waterproof and dustproof features, achieving IP66/IP67 waterproof ratings.

The structural anti-glare design of our outdoor ceiling lights effectively reduces the UGR, delivering bright and comfortable light in outdoor spaces.

It provides optimal illumination while minimizing discomfort caused by glare.



LED Recessed Ceiling Light

Website: [WWW.iliteuk.com](http://WWW.iliteuk.com)  
Email: [sales@iliteuk.com](mailto:sales@iliteuk.com)  
Address: 1 Hatton Street, London, United Kingdom, NW8 8PL

## LED IP67 Ceiling Light

CE ERP IP67 RoHS 1-10V Triac PWM DALI RGBW

### 7095R1\*α-A1-X

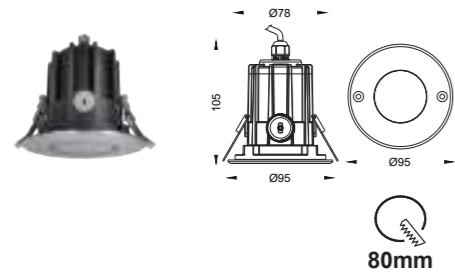

Power	LED	CCT	IK	Luminous	Input Voltage	Beam Angle
1x2W	CREE/OSRAM	Single	IK10	157lm	12/24 VDC/220-240VAC	8°/15°/25°/40°/60°/10°45°/20°65°
1x3W	OSRAM	RGB 3in 1	IK10	--	12/24 VDC	12°/25°/40°/60°
1x4W	OSRAM	RGBW 4in 1	IK10	--	12/24 VDC	12°/25°/40°/60°

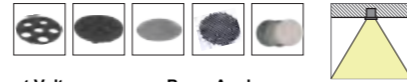

### 7210R1\*α-A1-X

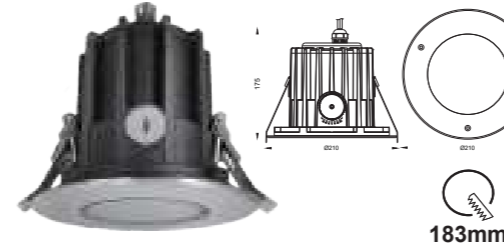

Power	LED	CCT	IK	Luminous	Input Voltage	Beam Angle
9x3W	CREE XPG	Single	IK10	1800lm	12/24 VDC/220-240VAC	3°/8°
12x2W	CREE/OSRAM	Single	IK10	1800lm	12/24 VDC/220-240VAC	15°/25°/40°/60°/10°45°/20°65°
1x25W	CREE COB	Single	IK10	1800lm	12/24 VDC/220-240VAC	18°/24°/38°/60°

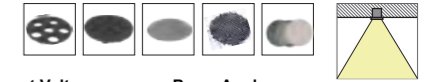

### 7130R1\*α-A1-X

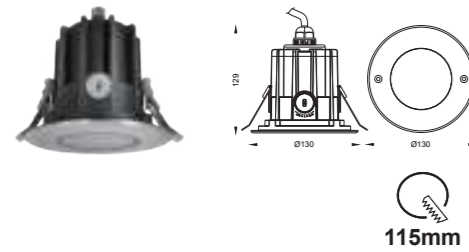

Power	LED	CCT	IK	Luminous	Input Voltage	Beam Angle
2x3W	CREE	Single	IK10	465lm	12/24 VDC/220-240VAC	3°/8°
3x2W	CREE/OSRAM	Single	IK10	465lm	12/24 VDC/220-240VAC	15°/25°/40°/60°/10°45°/20°65°
1x6W	CREE COB	Single	IK10	465lm	12/24 VDC/220-240VAC	18°/24°/38°/60°

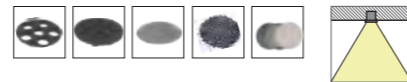

### 7055R1\*α-A3-X

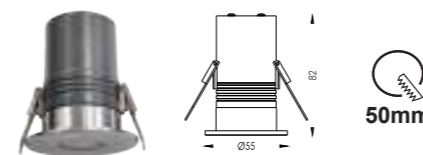

Power	LED	CCT	IK	Luminous	Input Voltage	Beam Angle
1x2W	CREE/OSRAM	Single	IK08	170lm	12/24 VDC/220-240VAC	8°/12°/25°/40°/60°/10°45°/25°45°
1x3W	CREE/OSRAM	RGB 3in 1	IK08	75lm	12/24 VDC	8°/12°/25°/40°/60°/10°45°/25°45°
1x4W	CREE/OSRAM	RGBW 4in 1	IK08	100lm	12/24 VDC	8°/12°/25°/40°/60°/10°45°/25°45°

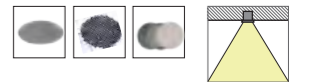

### 7160R1\*α-A1-X

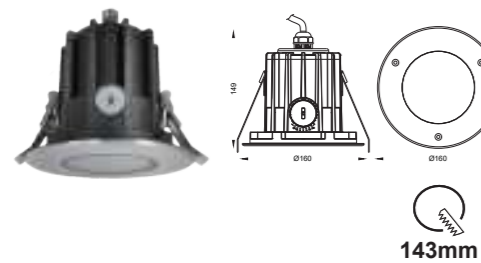

Power	LED	CCT	IK	Luminous	Input Voltage	Beam Angle
4x3W	CREE	Single	IK10	920lm	12/24 VDC/220-240VAC	3°/8°
6x2W	CREE/OSRAM	Single	IK10	920lm	12/24 VDC/220-240VAC	15°/25°/40°/60°/10°45°/20°65°
1x12W	CREE COB	Single	IK10	920lm	12/24 VDC/220-240VAC	18°/24°/38°/60°

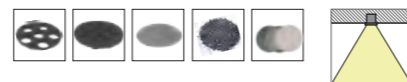

### 7070R1\*α-B3-X

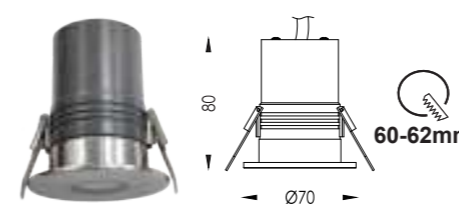

Power	LED	CCT	IK	Luminous	Input Voltage	Beam Angle
1x5W	CREE COB	Single	IK09	508lm	12/24 VDC/220-240VAC	15°/24°/36°/60°
1x6W	OSRAM	RGB 3in 1	IK09	170lm	12/24 VDC	8°/15°/25°/40°/60°
1x8W	OSRAM	RGBW 4in 1	IK09	225lm	12/24 VDC	8°/15°/25°/40°/60°

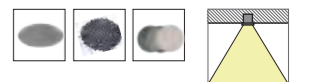

### 7180R1\*α-A1-X

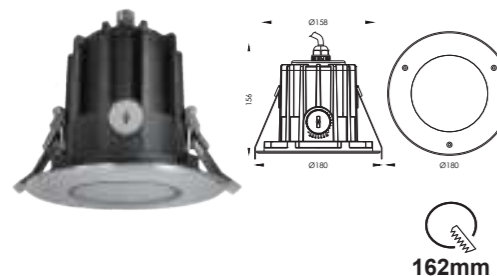

Power	LED	CCT	IK	Luminous	Input Voltage	Beam Angle
6x3W	CREE	Single	IK10	1310lm	12/24 VDC/220-240VAC	3°/8°
9x2W	CREE/OSRAM	Single	IK10	1310lm	12/24 VDC/220-240VAC	15°/25°/40°/60°/10°45°/20°65°
1x20W	CREE COB	Single	IK10	1245lm	12/24 VDC/220-240VAC	18°/24°/38°/60°

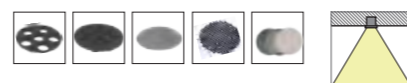

# Installation

## Recessed Under Water Light

### 1 Install conduit tube

Put the conduit tube through the nut and rubber plug

#The conduit tube should reach the bottom of the rubber plug

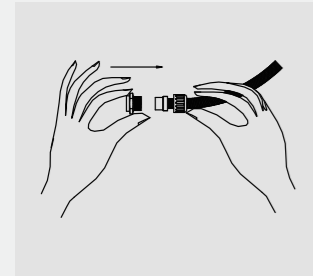

### 2 Fasten the nut

Fasten the nut with the screw by using a tool.

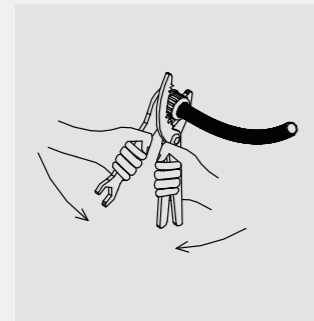

### 3 Installing cables

Put the cable through the conduit tube and the hole of the mounting sleeve from outside.

Then insert the cable into the nut/rubber plug and the PG13.5 cable gland

Fix the nut of the PG13.5 cable gland tightly

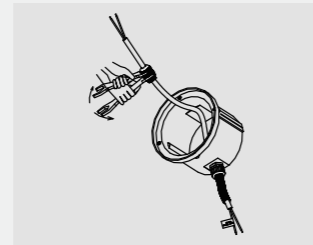

### 4 Fix the back cover

Screw the PG13.5 with the connector on the conduit tube tightly with two wrenches.

Fix the back cover to the mounting sleeve by four screw.

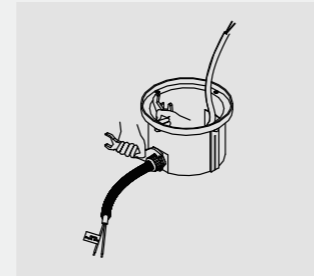

### 5 Fixed bracket

Fix the two type "L" bracket on the mounting sleeve.

Dig a hole for the installation for mounting sleeve.

#The distance between these hole and the ground should be less than 1M.

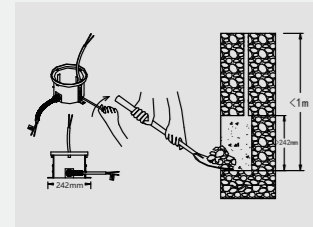

### 6 Placing sleeves

Put the mounting sleeve into the hole.

Fasten it with the wall if the pool by a screw driver.

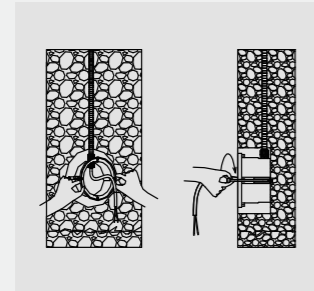

### 7 Connecting devices

Connect the lighting fixture with the power cable by connector.

Fasten the connector tightly to make sure it can reach Ip68.

Fix the light with the mounting sleeve by a screw driver.

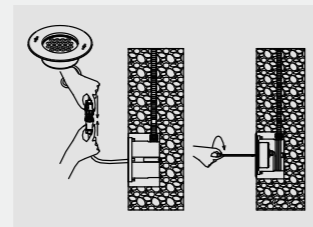

### 8 Complete installation

Pour the water into the pool after the installation.

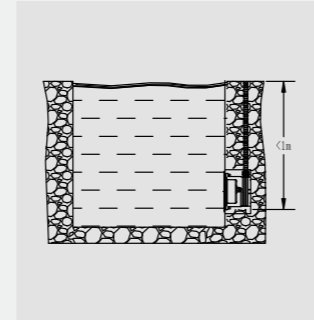

## Garden Spot Light

### 1 Disassemble the base

Loosen the M5 screws and remove the lamp base bracket.

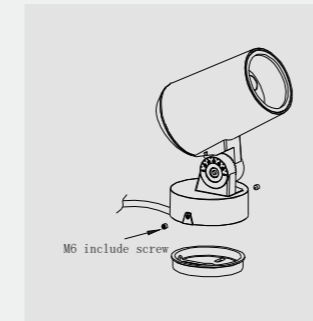

### 2 Positioning drilling

Drill two holes on the floor according to the hole position of the base support, and put rubber plugs or wood blocks into the holes.

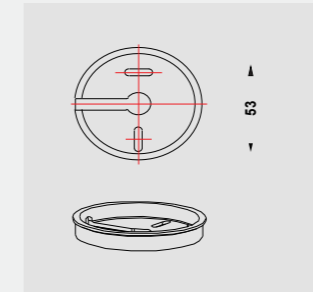

### 3 Fixed base

Fix the base bracket with wood screws

On the wall or the floor.

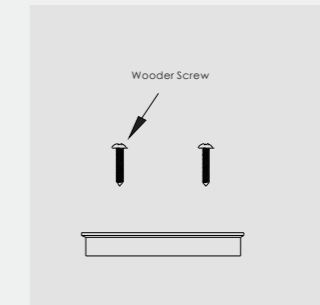

### 4 Placing the power cord

Insert the power cable of the lamp into side hole of the base support.



### 5 Angle adjustment

Put the lamp into the base bracket, adjust the X-axis angle of the lamp, and then lock the screws.



### 6 Angle adjustment

Put the lamp into the base bracket, adjust the X-axis angle of the lamp, and then lock the screws.

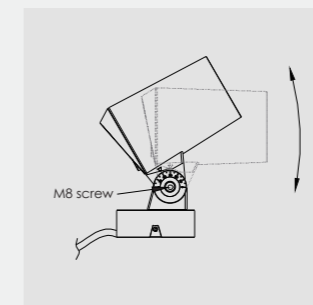

### 7 Reset power cord

Put the power cord and the power cord of the lamp into the Ip67 waterproof connector.

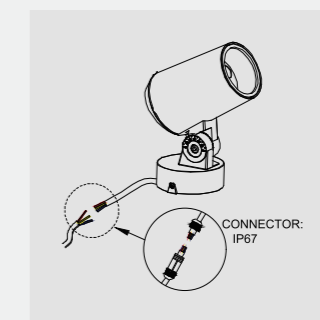

### 8 Complete installation

Connect the power cord with the power cord of the lamp, and then lock the waterproof connector.

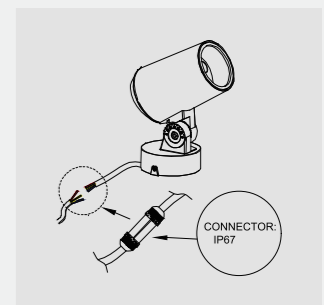

## Recessed Inground Light

### 1 Installing sleeve

Install the mounting sleeves on the ground, the top side should be on the same level with the ground surface, power cable need to go through the mounting sleeve.

Note: The thickness of the gravel must be thicker than 25mm.

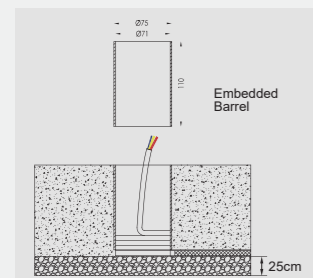

### 2 Connecting devices

Connect the power cable with the lighting fixture.

\*Keep enough length for maintain\*

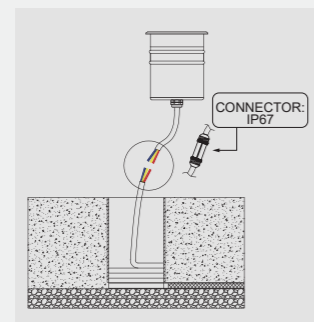

### 3 Fixed equipment

Fix the lighting fixture with the mounting sleeve by a screw driver.

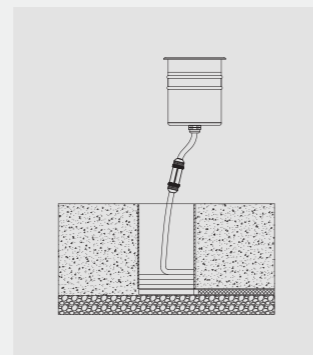

### 4 Complete installation

Organize cables and complete installation.

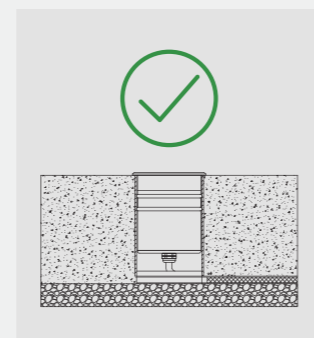

## Surface Wall Light

### 1 Positioning drilling

Loosen the M4 screws and remove the lamp support.

Drill four fixing holes and one threading hole on the wall according to the holes on the support.

Insert a rubber plug or wood block in to the holes.

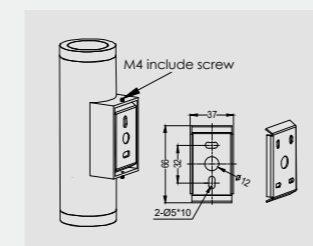

### 2 Fixed bracket

Pullout a power cord from the wall and pass it through threading hole and then fix the support on the wall with wood screws.

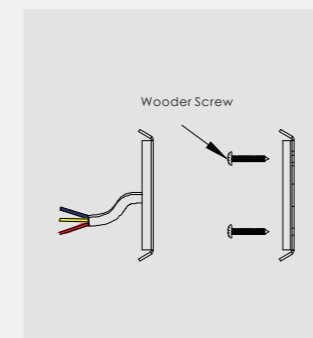

### 3 Connect the power cord

Connect power cord to the power cable of the lamps, and then tie with waterproof tape (waterproof measures must be taken)

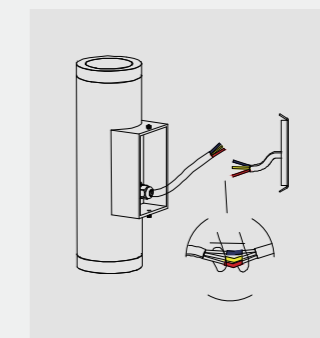

### 4 Complete installation

Put the long cable in place, then put the lamp into the support and lock the M4 MI screws.

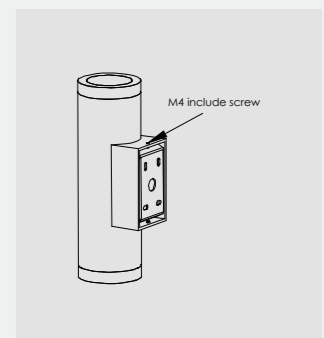

# Connection Diagram

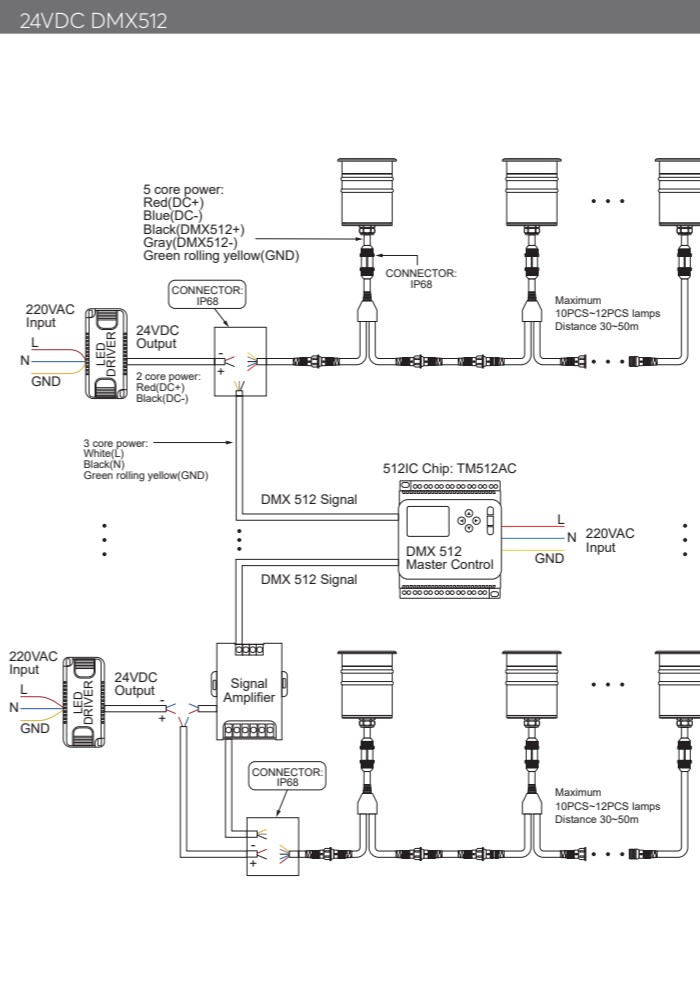
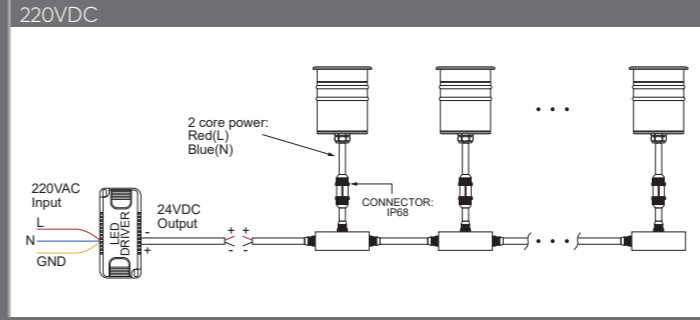
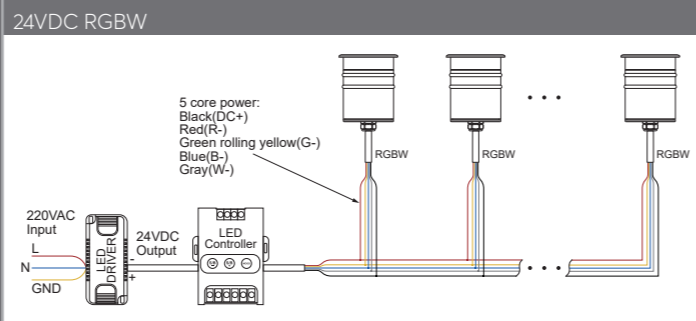
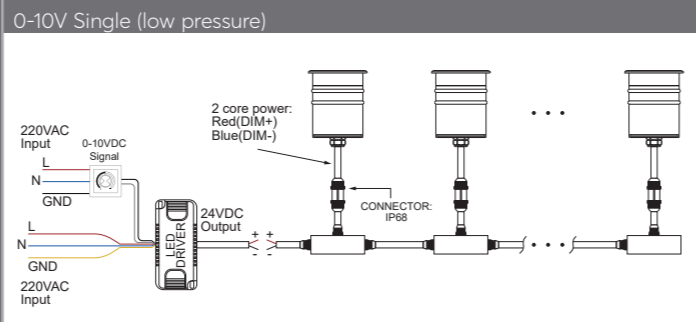
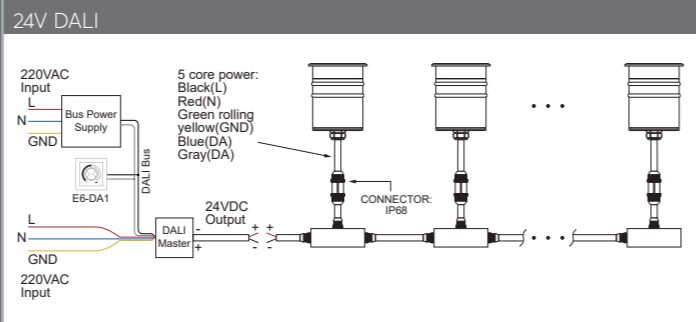
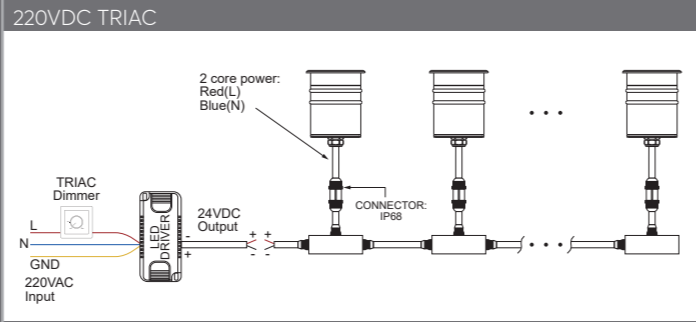
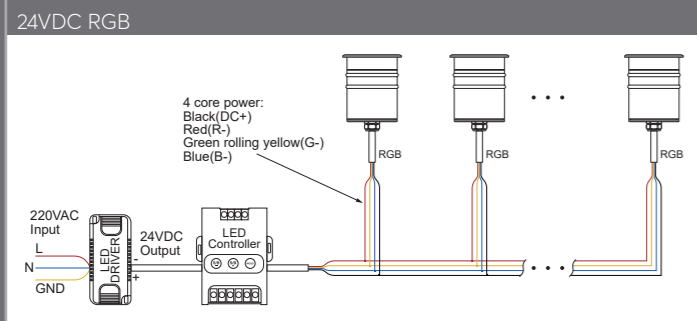
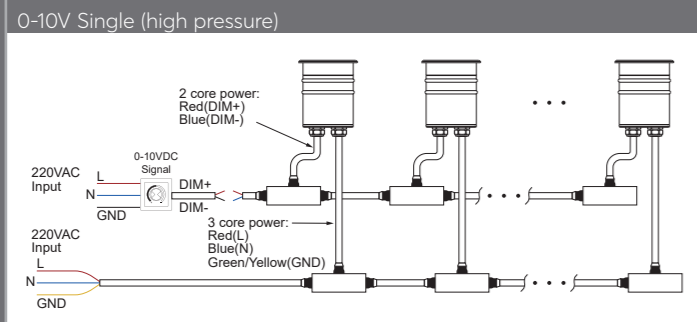
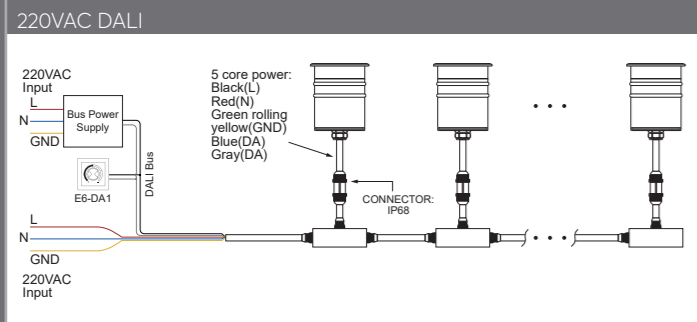
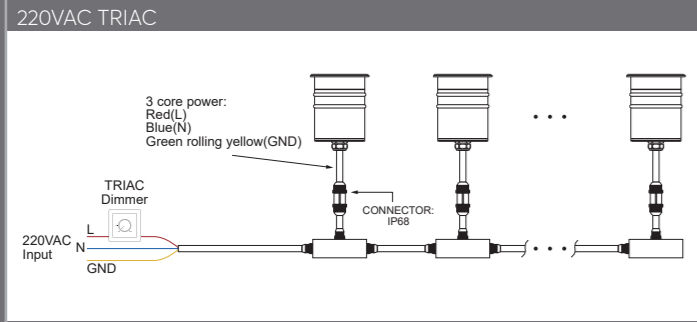
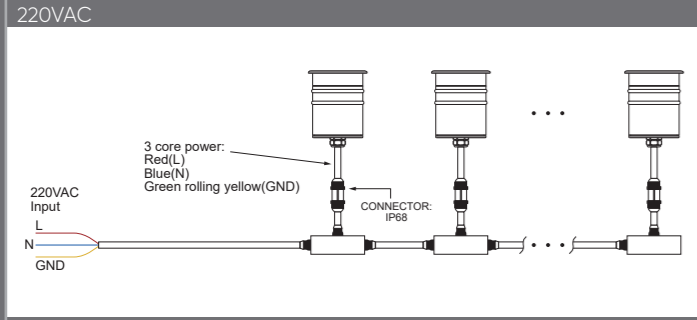

## Safety tips before installation

- \*Please ask an expert/authorized technician to do the installation.
- \*Please cut off the power before installing to prevent electric shock.
- \*Please always try to leave some space for the heat sink of the LED light. The light needs to be cooled after use.
- \*Do not connect any LED lights without recommended drivers.
- \*Your individual product may vary from the design shown below.
- \*Do not disassemble your product.
- \*Any damage caused by any modification or incorrect installation will void the warranty